

# INSTRUCTION MANUAL



## EDITIONS:

2013 03 15  
2013 10 15  
2013 11 23  
2014 02 28  
2014 04 04  
2014 04 05  
2014 12 02  
2014 12 03  
2014 12 10  
2014 12 16  
2015 02 04  
2015 04 10  
2015 05 27  
2015 07 21  
2015 10 20  
2015 12 07  
2016 02 11  
2016 03 14  
2016 04 05  
SW 01.20.0001 - 2016 09 22  
2016 12 10  
SW 01.20.0150 - 2017 01 31  
2017 05 16  
2017 10 12  
SW 01.22.0001 - 2017 12 20  
2018 05 03  
SW 01.24.0001 - 2018 07 30  
2018.12.18  
2019 05 25  
Added: Startset with the Maus - 2019 10 19

## **CENTRAL COMMAND STATION MX10**

*digital command station*

## **and MX10EC**

*The Economy  
digital command station*

## CONTENTS

Chapter	
Page	
1.	<i>The first start-up of a ZIMO system</i> .....8
2.	<i>Power supply and technical data</i> .....9
3.	<i>Typical system arrangement</i> .....10
4.	<i>The "Connection and distribution board" MX10AVP</i> .....18
5.	<i>Rail connections, programming track, AOS in/out</i> .....21
6.	<i>Track signal, Feedback, Database</i> .....23
7.	<i>MX10 update, data import and storage</i> .....24
8.	<i>Usage and operating elements</i> .....25
9.	<i>"Roco Z21" app and other apps on the MX10</i> .....40
10.	<i>Interlocking Program "ESTWGJ" on the MX10</i> .....41
11.	<i>USB connection to the computer</i> .....43
	<i>Annex: EMV audit report / TÜV Austria</i> .....44
	<i>Annex: Declaration of Conformity and Warranty</i> .....44

## CHANGE PROTOCOLING of these Operating Instructions

Until 2018 12 18: no records

2019 05 25: Installation of the MX10EC in the operating instructions and various corrections:

Pages 1,2,3 - MX10EC, new design (so far only page 1)

Page 6,7 - MX10EC front and back images

Page 8 - Text and images

Page 9 - Supplementing the technical data

Page 10 - Inserting "MX10 or MX10EC", new text

Page 15 - Note on types of Massoth radio receivers

Page 33 - "Bus Config+Monitor" Menu Item

Pages 16 ... 18 - Page breaks

Page 19 - MX10EC Programming Track, Addition MX10EC Emergency Stop

Page 23 - MX10EC Section about Normal Screen added

2019 09 01: Occasion: Start of delivery of the "Starset with the maus", MX10 or MX10EC with Roco WLAN

Multimaus Pages 9, 10 inserted

This **instruction manual** contains elements which refer to features that are not yet fully implemented.  
The final implementation may differ from the descriptions and display pictures.

## ***Notes to software versions and instruction manuals***

### **SOFTWARE und SOFTWARE-UPDATES:**

Find information regarding the **current software version** at the ZIMO website [www.zimo.at](http://www.zimo.at), under the tab **Update & Sound** ("Update - System"). The download is free of charge.

### **General information:**

- Do not use ZIMO devices in excessively warm or humid locations. The air flow must not be restricted (e.g. by covering) when in operation.
- Cable links shall not be squeezed or put under tension. A tight fit of all connectors is a prerequisite for faultless power or data transmission.
- The devices should not remain under power unattended, i.e. the power supply (or power supplies) should be disconnected from the power grid, ideally via a switchable power bar or by pulling the plug from the grid.
- Children under the age of 8 years must be under supervision of an adult when operating the device.
- Improper use or opening of the device without consulting ZIMO may lead to danger or loss of warranty.



Display (128 x 32, RGB backlight)

	<b>Normal screen</b>	<b>BLUE</b>	Voltages, currents, track 1 / 2, communication statistics, AOS
⤵⤵	VOLT & AMP main configuration	<b>YELLOW</b>	Output voltage, maximum current track 1, track 2
⤵⤵, T. 1 (↴)	VOLT & AMP detailed configuration	<b>YELLOW</b>	All possible configurations concerning voltage and current, such as: Turn-off times, tolerance
2 sec ↓	STOP & OFF	<b>RED</b>	Broadcast Stop BCS, OFF track 1, track 2, overcurrent OVC (short circuit)
Button 3 (↶)	BaseCab LOCO	<b>GREEN</b>	Set loco address, drive with rotary knob, activate functions per buttons
Button 2	MENU	<b>GREY</b>	Select menu points by scrolling and pressing the rotary knob
M, ⤵, ↓	DCC SERV PROG settings	<b>YELLOW</b>	CV programming and read-out on the programming track (track 2)
M, ⤵, ↓	MX10 Config	<b>GREY</b>	Various settings like language, radio channel, sniffer input, booster, etc. Information on software version, information statistics, date/clock, etc.
⏏ flash drive.	UPDATE & SOUND	<b>GREY</b>	Update decoder and load sound from the flash drive

USB (Host) socket

Slot for the flash drive.

⇒ Insert → UPDATE & SOUND

Select files to update the decoder or to load sound, also for MX10's self-update.

ZIMO CAN and XNET sockets

- for a 6-pole connection to ZIMO controllers and modules; additionally on the 8-pole socket: Sniffer inputs.

Note: Stationary equipment modules StEin are NOT connected to this CAN socket, but to the socket on the rear side of the MX10.

The XNET socket is for the connection to ROCO Multimaus and others; additionally on the 8-pole socket: second ZIMO CAN bus and second XNET bus (in reserve).

Legend: ⤵⤵ Turn rotary knob fast ⤵⤵ rotary knob scrolling ↓ Rotary knob pressing ↴ Button 1 M button 2 ↶ button 3

MX10

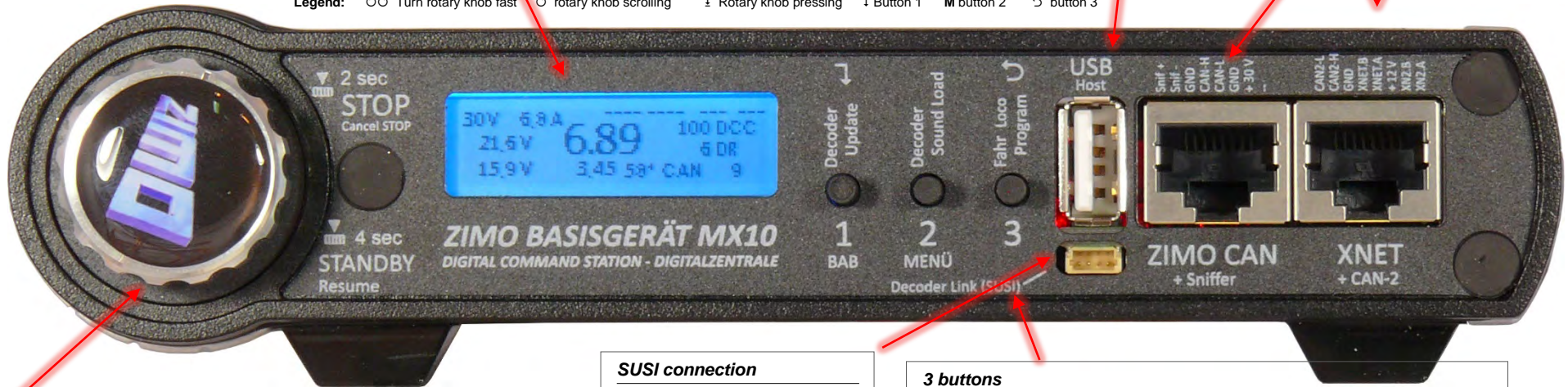

SUSI connection

Fast sound loading via SUSI interface.

Rotary knob

Normal operation **BLUE** - protection against erroneous activation: Press and rotate shortly → NO effect

⤵⤵ (Rotated fast) → operating state VOLT & AMP main settings (screen **YELLOW**)

↓ (Press long: 2 sec) → Broadcast Stop BCS and operating state STOP & OFF (screen **RED**)

↓ (Press 1 sec) → cancel broadcast stop, back to normal operation (or to operating state active before)

↓ (Press long: 4 sec) → ↓ SYSTEM STANDBY (track 1, 2 OFF, controller-supply OFF, display OFF, etc.)

Beyond normal operation (screen) - ⤵⤵ scroll and ↓ select, ⤵⤵ adjust ⤵⤵ drive ↓ direction, ...

3 buttons

Normal operation, normal screen **BLUE** -

Button 1 (↴) → operating sequences OPS, settings and control

Button 2 (M) → Menu to select operating states **GREY**

Button 3 (↶) → operating state "BaseCab LOCO" **GREEN**

STOPP & OFF (after pressing rotary knob 2 sec ↓ or short circuit) **RED**

Button 1 → BCS, OFF, ON track 1 button 2 → ... track 2

BaseCab LOCO **GREEN**

Buttons 1, 2, 3 → (after selecting a group) controlling functions

UPDATE & SOUND **BLUE (GREEN)**

Button 1 → Start decoder update

Button 2 → Start sound loading

Button 3 → (if not used differently) back to normal screen (**BLUE**)

**Primary supply**

power supply unit with  
 20 - 35 V =  
 80 - 600 watt  
 You can only use galvanically isolated power supply units!  
 MX10 powers up automatically after connecting/turning on the power supply unit.

**AOS inputs and LED outputs**

8 logic-level inputs (react to ground and positive voltage, e.g. track signal) for  
 - External buttons for emergency stop and emergency OFF,  
 - Track contacts for internal AOS (automatic operation sequences)  
 - Track contacts for external AOS (automatic operation sequences)  
 6 LED outputs (resilience of up to 25 mA) for  
 - Signals, various lights, controlled by AOS,  
 Supply pins 5V and GROUND.

**Sockets for ZIMO CAN and LAN**

CAN bus  
 - for a 6-pole connection to ZIMO controllers and modules; and/or  
 - for an 8-pole connection to ZIMO stationary equipment modules "StEin" and compatible boosters as well as booster input and booster-error output (CAN and synchronization for external DCC-power amplifiers).  
 LAN interface as networkable alternative to an USB-computer connection, or to a WiFi router (tablet apps, etc.)

**2.4 GHz antenna for Mi-Wi radio**

To communicate with radio modules, ZIMO uses "Mi-Wi", a "mesh network" based on components and software of the company Microchip, derived from the ZigBee standard. The messages are forwarded from nod to nod until they reach their destination, even if there is no direct radio connection at the moment.

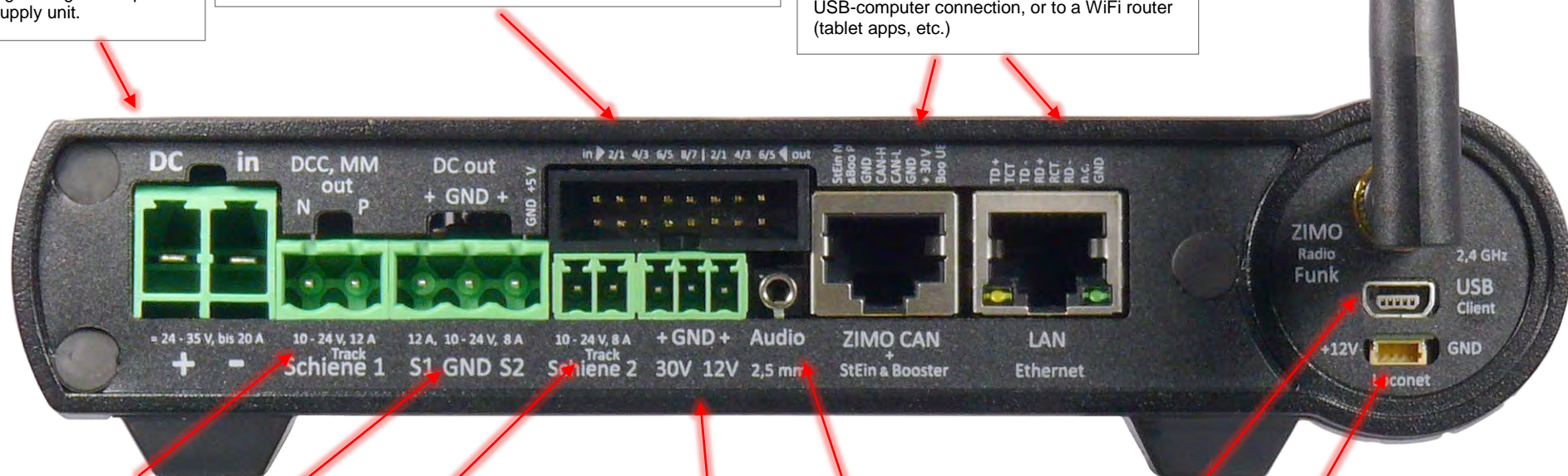

**Outputs: Track 1 | track DCs (DC out) S1, S2 | track 2**

2-pole socket "Schiene 1" (track 1) - usually main track  
 2-pole socket "Schiene 2" (track 2) - usually programming track, additional circuit  
 "Digital current" (DCC, MM, in the future possibly other track formats as mfx, sx)  
 Polarity N,P without meaning in simple applications important on layouts with sections or track sections (MX9, StEin, booster application)  
 Outputs track 1, track 2 regarding voltage, current limits, etc.  
 have to be configured independently, depending on configuration and situation they use the same or a different data signal.  
 3-fold socket "DC out" " - S1, GROUND, S2 (S=track)  
 to supply stationary equipment modules StEin, track section modules, terminal loop modules, and others (within the MX10 DCC power amplifiers).  
 All necessary connectors are included in the scope of supply.

**Audio socket (line out)**

For an amplified playback of sounds which are primarily reproduced by an internal speaker (from warning signals to sound projects; application is not yet defined).

**Connection to power**

Regulated DC connection ground 12 and 30 Volts.

**USB (device) socket**

Connection to the computer via USB to use with interlocking and configuration software.  
 The transmission rate corresponds to 1 M Baud; the necessary protocol can be downloaded from our web-site.

**LocoNet plug**

Prepared for implementation.



**Display (128 x 32, RGB backlight)**

<b>Normal screen</b>	<b>BLUE</b>	Voltages, currents, track 1 / 2, communication statistics, AOS
<b>⤵⤵</b> VOLT & AMP main configuration	<b>YELLOW</b>	Output voltage, maximum current track 1, track 2
<b>⤵⤵, T. 1 (1)</b> VOLT & AMP detailed configuration	<b>YELLOW</b>	All possible configurations concerning voltage and current, such as: Turn-off times, tolerance
<b>2 sec ↓</b> STOP & OFF	<b>RED</b>	Broadcast Stop BCS, OFF track 1, track 2, overcurrent OVC (short circuit)
<b>Button 3 (3)</b> BaseCab LOCO	<b>GREEN</b>	Set vehicle address, drive with rotary knob, activate functions per buttons
<b>Button 2</b> MENU	<b>GREY</b>	Select menu points by scrolling and pressing the rotary knob
<b>M,⤵, ↓</b> DCC SERV PROG settings	<b>YELLOW</b>	CV programming and read-out on the programming track (track 2)
<b>M,⤵, ↓</b> MX10 Config	<b>GREY</b>	Various settings like language, radio channel, sniffer input, booster, etc. Various information like software version, information statistics, date/clock, etc.
<input type="checkbox"/> flash drive.	<b>GREY</b>	Update decoder and load sound from the flash drive

**USB (Host) socket**

Slot for the flash drive.  
 ⇨ Insert → UPDATE & SOUND  
 Select files to update the decoder or to load sound, also for MX10's self-update.

**ZIMO CAN and XNET sockets**

On the MX10EC: CAN bus only on the rear of the device!  
 The XNET socket is used for the connection to ROCO Multimaus and others; additionally provided on the 8-pole socket: second ZIMO CAN bus and second XNET bus (in reserve).

**Legend:** ⤵⤵ Turn rotary knob fast ⤵ rotary knob scrolling ↓ Rotary knob pressing 1 Button 1 M button 2 3 button 3

MX10EC



**SUSI connection**

Fast sound loading via SUSI interface.

**Rotary knob**

Normal operation **BLUE** - protection against erroneous activation: Press and rotate shortly → NO effect  
 ⤵⤵ (Rotated fast) → operating state VOLT & AMP main settings (screen **YELLOW**)  
 ↓ (Press long: 2 sec) → Broadcast Stop BCS and operating state STOP & OFF (screen **RED**)  
 ↓ (Press 1 sec) → cancel broadcast stop, back to normal operation (or to operating state active before)  
 ↓ (Press long: 4 sec) → SYSTEM STANDBY (track 1, 2 OFF, controller-supply OFF, display OFF, etc.)  
 Beyond normal operation (screen) - ⤵⤵ scroll and ↓ select, ⤵⤵ adjust ⤵⤵ drive ↓ direction, ...

**2 buttons**

Normal operation, normal screen **BLUE** -  
 Button 1 (1) → operating sequences OPS, settings and control  
 Button 2 (MENU) → Menu to select operating states **GREY**  
 Button 1 → BCS, OFF, ON track 1 button 2 → ... track 2  
 BaseCab LOCO **GREEN**  
 Buttons 1, 2 → (after selecting a group) controlling functions  
 UPDATE & SOUND **BLUE (GREEN)**  
 Button 1 → Start decoder update  
 Button 2 → Start sound loading

**Primary power supply**

power supply unit with  
 20 - 35 V =  
 80 - 600 watt  
 You can only use galvanically isolated power supply units!  
 MX10 powers up automatically after connecting/turning on the power supply unit.

**Sockets for ZIMO CAN and LAN**

CAN bus  
 - for a 6-pole connection to ZIMO controllers and modules; and/or  
 - for an 8-pole connection to ZIMO stationary equipment modules "StEin" and compatible boosters as well as booster input and booster-error output (CAN and synchronization for external DCC-power amplifiers).  
 LAN interface as networkable alternative to an USB-computer connection, or to a WiFi router (tablet apps, etc.)

**2.4 GHz antenna for Mi-Wi radio**

To communicate with radio modules, ZIMO uses "Mi-Wi", a "mesh network" based on components and software of the company Microchip, derived from the ZigBee standard. The messages are forwarded from nod to nod until they reach their destination, even if there is no direct radio connection at the moment. It can be expanded to train radio.

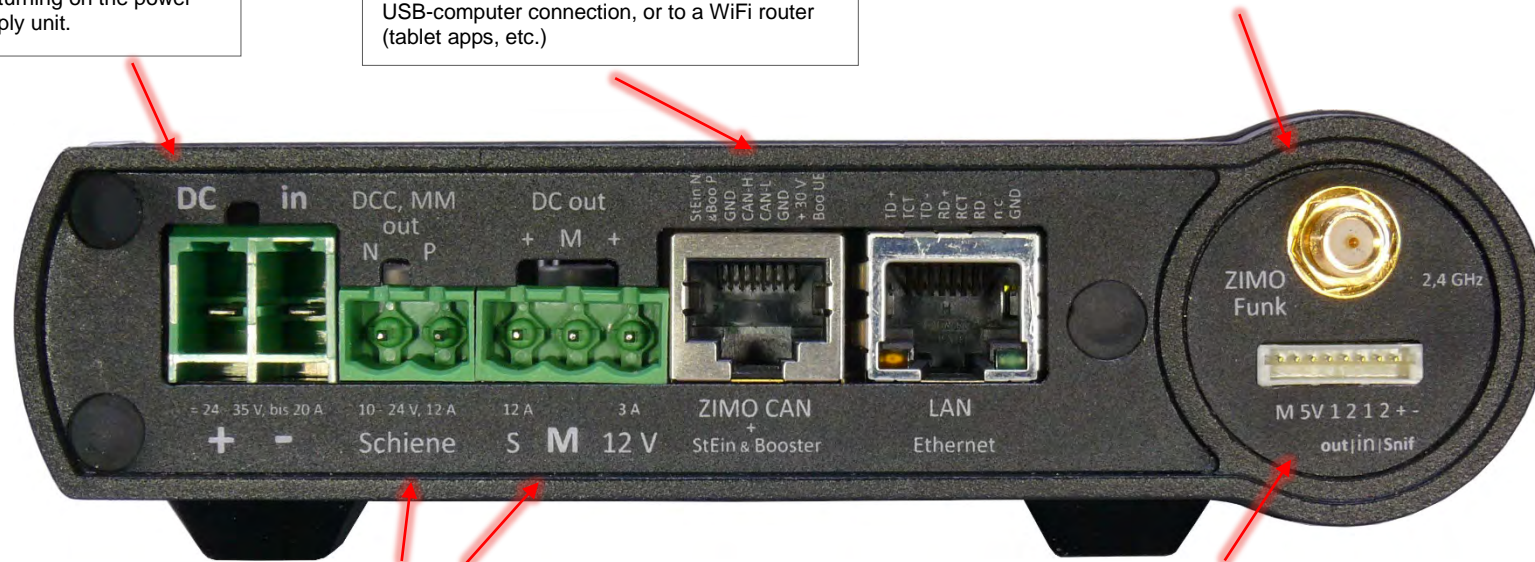

**Outputs: Track / Track DC (DC out)**

2-pole socket "track" - usually main track / programming track  
 "Digital current" (DCC, MM, in future possibly other track formats like mfx, sx)  
 Polarity N,P without meaning in simple applications, important on layouts with sections or track sections (MX9, StEin, booster application)  
 Settings for the output "track": Voltage, current limits, etc.  
 3-fold socket "DC out" " - S, GROUND, 12 V (S=track) to supply stationary equipment modules StEin, track section modules, terminal loop modules, and others (within the MX10 DCC power amplifiers).  
 All necessary connectors are included in the scope of supply.

**AOS inputs and LED outputs**

8 logic-level inputs (react to ground and positive voltage, e.g. track signal) for  
 - External buttons for emergency stop and emergency OFF,  
 - Track contacts for internal AOS (automatic operation sequences)  
 - Track contacts for external AOS (automatic operation sequences)  
 6 LED outputs (resilience of up to 25 mA) for  
 - Signals, various lights, controlled by AOS,  
 Supply pins 5V and GROUND.



# 1. The first start-up of a ZIMO system

Here: The "Startsets with the Maus" see two pages later

The ZIMO system usually is delivered s "start set".

There are different variations of startsets, depending on the types of Central command stations and controllers, this means:

**1 central command station**

MX10 or MX10EC (Economy)

**1 power supply unit**

NG300 (320 VA) or NG600 (600 VA)

**1 controller**

MX32 or MX32FU (radio)

as well as various plugs, CAN cable, Power cable (depending on the country you maybe need an adapter or a replacement).

The best-selling start set is the

**STARTFU**

= MX10 + MX32FU + NG300 (320 VA)

(NOTE: 320 VA since 2019, before 240 VA)

**Start-up:**

Additionally, the most important connections have to be made with the existing material:

- ★ The controller (one of the two sockets) has to be connected to the MX10 (socket "ZIMO CAN" on front ant rear side) or the MX10EC (ZIMO CAN only on rear side) via the → CAN cable.

ATTENTION: two cables are supplied; the correct one has identical connectors on both sides (Without colored tube).

- ★ The layout with a self-made cable (using the supplied double screw clamp connectors → Double screw clamp "Schiene 1" (track 1) or "Schiene 2" (track 2) of te MX10 or Double screw clamp "Schiene" (track) of the MX10EC.

"Track 2" (MX10) or "Track" (MX10EC) can be changed (on the controller) to a programming track function to "Service Mode". NOTE: Modern decoders do no really need an programming track anymore.

- ★ The power supply unit via a connected cable (big double screw clamp connector at the end) to the supplying socket "DC in" of the MX10 or MX10EC.

The supply is only working with the correct polarity on "DC in" (but NO dangerr in case of wrong polarity).

Finally: Power supply via the supplied "cold-device cable" to the power grid (110 - 250 V).

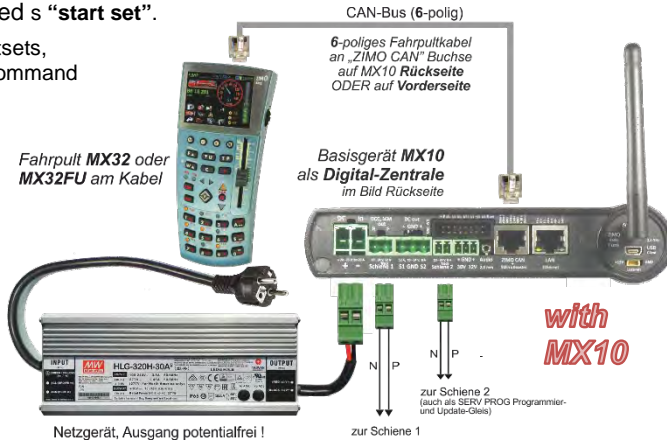

- ★ The command station MX10 or MX10EC starts up as soon as there is voltage applied to "DC in". The start-up phase (red screen, after a few seconds it turns blue) starts. The connected controller (or controllers) starts (about 30 sec).

- ★ The controller starts its operation at the end of the start-up phase...

- (if it is new or "empty")

... in the operating state **LOCO IN**

here: enter desired vehicle address!

if it is not "empty", because it was used before but not cleared completely,

... with **LOCO** or **SWI**.

The vehicle with the shown address can now be maneuvered. Change to **LOCO IN** by pressing the **A-button**, where a new address can be entered.



A-key



Address



F-key



A-key



- ★ To manoeuvre another train, first press the **A-key**; in the operating state **LOCO IN** the new address is entered (maybe also add a name), and then the address is activated by pressing the **F-key**.



## 2. Power supply and technical data

The central command station MX10 and all connected controlling devices (and the whole layout) are supplied by an external power supply unit. This supplies the "primary voltage". As power supply unit a product from ZIMO or from another manufacturer can be used, as long as it fulfills the basic requirements:

on the "DC in" input:

<b>external power supply unit</b> with galvanically isolated DC output ...	<b>20 - 35 V</b>
reasonable maximum voltage of the power supply unit .....	3 - 30 A
for minimum operation (about 3 A rail current).....	80 Watt
for operation with full power (up to 25 A total rail current).....	<b>600 Watt</b>

All power supply units provided by ZIMO correspond to these criteria. The current products can be looked up in our product- and pricelist. The example shown here is **ZIMO's standard power supply unit NG300 (30V / 320 VA)**, this is currently delivered with start sets, but also available separately. Alternatively (also for „G-start set“): **NG600 (30 V / 600 VA)**.

The track voltages on the outputs of the MX10 (MX10EC) are NOT like the power supply unit output voltage; they are reduced within the MX10 by a DC converter inside the MX10 to 10 - 24 V, depending on **Voltage & Current settings** (see equally-named chapter).

The difference between the input voltage of the MX10 (also output voltage of the power supply unit) and track output voltage has to be 3V or more due to the internal consumption of the MX10. Therefore, the track voltage has to be set to at least 3 V less than the voltage supplied by the power supply unit.

The total current of the track outputs can be higher than the current supplied by the power supply unit: the higher the total current (up to the double), the lower the track voltages are configured compared to the voltage of the power supply unit. This means that in case of a 240 W power supply unit, the total rail currents can be calculated between 8 A (about 24 V) and 15 A (12 V).

Additionally to the track outputs there are other consumers (own consumption, connected cabs, etc.), which limit the available power depending on their configuration.

The output of the power supply unit is connected to the "DC in"-socket on the MX10's (or MX10EC's) back side.

### Observe the polarity (+/-)!

If it is connected wrongfully, the MX10 does not start, but it CAN-NOT be damaged.



MX10. rear side



**ATTENTION:** Standard transformers of all kinds (not even with rectifier) as well as **ZIMO transformers** (although they were used for the MX1) and **old model railway transformers** **MUST NOT** be used with an MX10! (Because of legal regulations and because MX10 / MX10EC are only designed for regulated power supplies)

Output track 1 (MX10) or track (MX10EC)			Default
- Voltage	(adjustable in 0.2 V steps)	10 to 24 V	16 V
- Start-up voltage	(adjustable in 1 A steps)	1 to 12 A	5 A
- Start-up time of the voltage	(adjustable in 1 sec steps)	1 to 60 sec	1 sec
- overcurrent threshold	(adjustable in 0.1 A steps)	1 to 12 A	5 A
- Turn-off time in case of overcurrent	(adjustable in 0.1 sec steps)	0.1 to 5 sec	0.2 s
- Tolerated overcurrent threshold surpassing	(adjustable in 0.5 A steps)	0 to 4 A	0 A
	for a time of	(adjustable in 0.5 sec steps)	1 to 60 sec
- Spark suppression (selection between Off/Lev1/Lev2)	Level 1 / Level 2 (sensitive)	8 A / 4 A	OFF
Output track 2 (NOT on the MX10EC):			Default
- Voltage	(adjustable in 0.2 V steps)	10 to 24 V	16 V
- Start-up voltage	(adjustable in 1 A steps)	1 to 8 A	3 A
- Start-up time of the voltage	(adjustable in 1 sec steps)	1 to 60 sec	1 sec
- overcurrent threshold	(adjustable in 0.1 A steps)	1 to 8 A	3 A
- Turn-off time in case of an overcurrent	(adjustable in 0.1 sec steps)	0.1 to 5 sec	0.2 s.
- Tolerated overcurrent threshold surpassing	(adjustable in 0.5 A steps)	0 to 4 A	0 A
	for a time of	(adjustable in 0.5 sec steps)	1 to 60 sec
- Spark suppression(selection between Off/Lev1/Lev2)	Level 1 / Level 2 (sensitive)	8 A / 4 A	OFF

DC outputs S1 and S2 (in the circuits for "track1" and "track 2")			
DC output 30 V	Only MX10	(Supply for devices connected via CAN bus cable) ...	4 A
DC output 12 V		(Supply for devices connected to XNET and LocoNet)	1.5 A
LED outputs	2 instead of 6 pins on the MX10EC	(6 pins on 2x8-pole pin conn.) - constant current at 15 mA "out 5" and "out 6" are suitable for relay	max. 25 mA 100 mA
AOS inputs	2 inst. of 6 pins on MX10EC	(8 pins on 2x8-pole pin conn.) to gnd or switching threshold	0 to 32 V
Audio output	Only MX10	(Jack socket 2.5 mm)	Line-out
<b>RailCom</b>	Detector track (1) / 2	measurable min. amplitude of the RailCom signals	4 mA
		Sample rate (3-fold oversampling)	750 kHz
<b>ZACK</b>	Detector track 1 / 2	Detection threshold	500 mA
Communication via cable			
<b>ZIMO CAN bus 1</b>		(ZIMO CAN sockets in the front and the back) prepared for	125 kBd
<b>ZIMO CAN bus 2</b>		(with special 8 pole. cable: XNET socket) depending on the protocol up to	512 kBd
XNET			62.5 kBd
XN2		(2) XNET or OPEN DCC bus) not yet in use	512 kBd
LocoNet		at this moment the software is not prepared	16.6 kBd
USB device (client) interface		Only if it's NOT an MX10EC	1 Mbit/s
USB 2.0 host interface		(for USB and future use)	12 Mbit/s
LAN		(Ethernet, also to connect a WiFi router)	10 Mbit/s
Communication via radio:	<b>Mi-Wi network</b>	(derivative of the ZigBee standard, 2.4 GHz)	~ 20 kbit/s
Internal memory:	DRAM and SRAM (random access memory)		64 MB
	NAND flash (pictures, databases, interlockings, sound files, etc)		4 4 GB

### 3. Typical system arrangement

#### 3.1 Startsets with the Maus

“Normal ZIMO start sets” (see first part of this chapter) contain a ZIMO controller additionally to the central command station (either MX32 or MX33, depending on time of delivery);

The start set with the maus, on the other hand, contains a **ROCO WIFI Maus** as single controlling unit, together with a preconfigured router (in two different versions)

- 1 central command station MX10 → results in **STARTWWM**
- or MX10EC (Economy) → results in **STARTECWM**

1 power supply unit NG300 (320 VA)

1 Multimaus Roco WIFI-Multimaus

1 WIFI router (type depends on availability)

As well as various plugs, CAN cable, Power cable (depending on the country you maybe need an adapter or a replacement).

The start set **STARTECWM** provides a cost-efficient start into the ZIMO control system; nevertheless it is very powerful: up to 12 A rail current (also for large-scales of 222V) and of course with all typical ZIMO features.

The **added router** in this start sets are **preconfigured**, so the startup of the WIFI Multimaus works without problems and you can immediately start maneuvering the trains. Naturally, the Roco **Z21 app** can be used at any time.

In case the WIFI connection does not work immediately, see chapter “Roco WIFI Z21 APP2 and WIFI Multimaus.

Of course, some of the ZIMO-typical features and display variations are not available in the start set with the Maus (without a ZIMO controller): no loco pictures, no function icons, no speedo, no broadcast stop, no RailCom feedback, no CV reading in POM (i.e. on the main track - also “OP PROG”), etc. - nevertheless, the central command stations MX10 and MX10EC are prepared for an **extension** with ZIMO controllers (MX32, MX33) including the radio versions (see picture).

How to handle the Roco WIFI Maus is described in Roco’s user manual:

[Z21 WLANMAUS Manual \(DE, EN, FR\)](#) (4,8 MB)

*This link is valid at the time of publication of this instruction manual. It is possible, Roco changes the location.*

Here - within the instruction manual of MX10 and MX10EC - only the typical start up is described, i.e. how the first train is maneuvered and the first turnout is switched.

Usually, the loco to be maneuvered has to be entered into the “library” (the easiest way is entering the address), to be able to select and manoeuvre it.

The WLAN mouse and router included in the ZIMO starter kit are already correctly set to ensure immediate operation. If there are any problems or the devices were not purchased within a start set, see chapter “Roco Z21 and WLAN mouse”.

SWITCH ON the WLAN Maus which has been switched off until now with "WLAN" is displayed, then the name of an active locomotive.

Use / to scroll through the entries in the selection list until the display shows **"NEW?"**, confirm with to start entering the new name with the numeric keys ... (at least 1 letter must be entered!)

Confirm finished name with to enter the address with ...

Confirm the entered address with to select speed step mode (128 suggested), confirm all entries with , new locomotive is included in selection list, Manoeuvre ...

SWITCH OFF the WLAN Maus through + press simultaneously

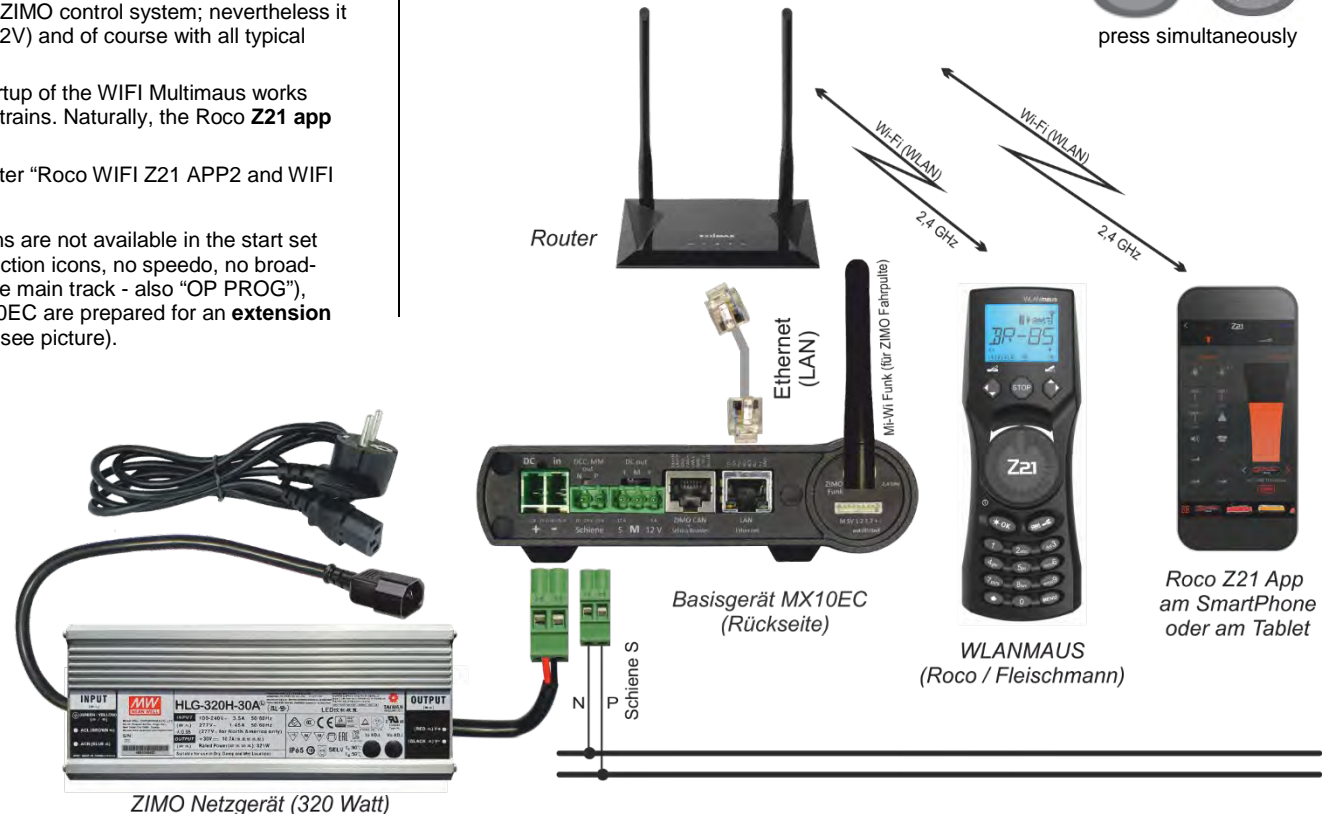



**Fahrsymbole**

- Pfeile zeigen Fahrtrichtung der gewählten Lok an
- Pause zeigt Stillstand der Lok an (per Regler oder selektivem Nothalt)

**Batteriesymbol**

- nicht sichtbar: Alles OK
- sichtbar: Batterie-/Akkuspannung sinkt
- blinkt: Batterien/Akkus austauschen

**Kurzschluss**

- Symbol blinkt bei einem Kurzschluss oder einer Überlastung

**Stop (Stop-Taste)**

- Symbol blinkt bei Nothalt und Kurzschluss

**Shift-Symbol**

- zeigt Betätigung der  $\wedge$ -Taste an

**Schraubenschlüssel**

- Menüebene: Einstellungs-Menü

**Weichensymbol** (Lok/Weichen-Taste)

- Weichen- oder Fahrweg-Modus
- Menüebene: Fahrwege-Menü

**Funksymbol**

- Das Symbol gibt Auskunft über die Funkverbindung

**Loksymbol (Lok/Weichen-Taste)**

- Fahr- oder Weichenbetrieb
- Menüebene: Lok-Menü

**Lichtsymb (★OK-Taste)**

- Loklicht eingeschaltet

**Funktionssymbole (1-10)**

- zeigen die eingeschalteten Lok-Sonderfunktionen an
- Menüebene: untergeordnete Ebenen

**ABC**

- leuchtet bei der Texteingabe

**MENU**

- die WLANmaus ist in der Menüebene

**Prog**

- leuchtet als Bestätigung bei der Programmierung. Menüebene: Programmieren-Menü

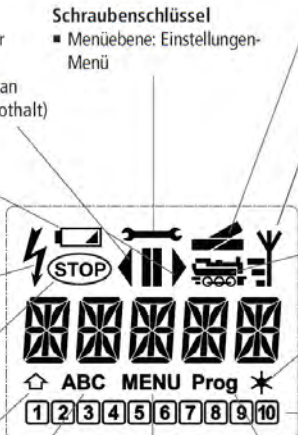

**Fahren | Driving | Circulation**

 /  = Lokauswahl / Loco selection / Sélection de locomtives  
 = Nothalt / Emerg. Stop / Arrêt d'urgence  
 = Licht / Light / Luce



**Funktionen | Functions | Fonctions**

 = F1-F10  
 = F11-F20  
 → Klick, Klick! / Click, Click! / Clic, Clic  
 = F21-F28

**Weichen | Turnouts | Aiguillages**

 →  →  =   
 =   
 zurück / back / retour = 



**LC-Display**  
LC display  
Écran

**Stop-Taste**  
Stop Key  
touche »Stop«

**Pfeiltaste (links)**  
Arrow Key (left)  
touche »flèche« (à gauche)

**Pfeiltaste (rechts)**  
Arrow key (right)  
touche »flèche« (à droite)

**Fahrregler**  
control knob  
bouton régulateur

**Licht / OK-Taste**  
Light / OK Key  
touche »feux / OK«

**Lok / Weichen-Taste**  
Loco / Turnout Key  
touche »Locomotive / aiguillages«

**Funktionstasten**  
Function Keys  
touches »fonctions«

**Shift-Taste**  
Shift Key  
touche »majuscules«

**Menü-Taste**  
Menu Key  
touche »Menu«



## 3.2 System arrangements with MX10 and MX10EC

The MX10 (or the MX10EC) is the central unit (digital command station) in every usage of the ZIMO system, therefore the traditional naming "central command station". According to NMRA-terminology, it is a mixture of "command control station" and "power station".

The central command station provides a stable, short circuit proof, running voltage on both track outputs and via these, the command station transmits controlling information for the loco decoders and accessory decoders, in DCC format \*) and/or (in future) in MOTOROLA format (which addresses the factory-mounted decoders in Märklin vehicles).

\*) **DCC** (Digital Command Control): The data format, originally standardised by the NMRA (National Model Railroad Association), and since 2010 further specified by the European manufacturer association VHDM ("RailCommunity"), is now used by the digital systems and decoders "Digital Plus" (Lenz), ROCO-digital, LGB multi-train control (Massoth), Digitrax, ESU, Uhlenbrock and others.

The MX10 (or MX10EC) is connected to other devices of ZIMO's product range via CAN cables. This means input devices, also called controllers (MX31, MX32, MX33, ...), stationary equipment modules (StEin) or accessory and track section modules (MX8; MX9 (addr.:801-863), MX9 (addr.:901-963)).

## MX10 (Full featured version) or MX10EC (Economy)

NOTE to the following chapters of this instruction manual

The MX10EC is completely based on the hardware and software on the MX10; it economizes some things - especially the output "track 2", to reduce costs and the prize:

### Differences:

- |                                                                                                           |                                                         |
|-----------------------------------------------------------------------------------------------------------|---------------------------------------------------------|
| <b>MX10:</b> "Schiene 1" (track 1) with 12 A A total) AND "Schiene 2" (track 2) with 8 A traction current | <b>MX10EC:</b> one „Schiene“ with 12 A traction current |
| <b>MX10:</b> Auxilliary voltage 30 V on screw terminal                                                    | <b>MX10EC:</b> 30 V on ZIOM CAN socket (weaker)         |
| <b>MX10:</b> Audio generator, speaker, output socket built-in                                             | <b>MX10EC:</b> no                                       |
| <b>MX10:</b> LAN socket and USB client to the computer                                                    | <b>MX10EC:</b> LAN socket                               |
| <b>MX10:</b> 8 logic-level inputs ("AOS"-inputs) and 6 "LED"-outputs                                      | <b>MX10EC:</b> 2 inputs, 2 outputs                      |
| <b>MX10:</b> Loconet connection built-in                                                                  | <b>MX10EC:</b> no                                       |
| <b>MX10:</b> ZIMO CAN bus accessible on front and rear side of the device                                 | <b>MX10EC:</b> Rear side                                |
| <b>MX10:</b> 3 buttons for operation                                                                      | <b>MX10EC:</b> 2 buttons, replacement by rotary knob    |

In the description of the system's arrangement, no difference is made between MX10 and MX10EC - the MX10 is named for both devices.

### Standard minimum setup of a ZIMO digital control with MX10(EC) and MX32:

Central command station + power supply unit + controller.

See graphics in chapter "Initial start-up of a ZIMO system" (some pages before)

### An extended equipment with several controllers and StEin modules:

MX32FU radio controllers can be used either in cable mode or, of course, in radio mode. In contrast to earlier ZIMO system generations, no additional radio module is required for use with the current MX10 digital command station because this is already integrated.

The following illustration shows examples of some "StEin" modules (stationary equipment modules) (see also further illustrations of system arrangements and instruction manuals of the StEin).

In the case shown, the StEin modules are supplied completely from the MX10 (3-pole "DC-out" socket with voltages S1, S2); a maximum of 5 StEin modules is recommended.

Otherwise, from 6 StEin modules upwards, instead of "S2" or "ZUB" from the MX10 an own power supply unit would have to be used (see following drawings).

This also applies when using an MX10EC, to which 1 StEin module can be connected directly for test purposes only for a short time.

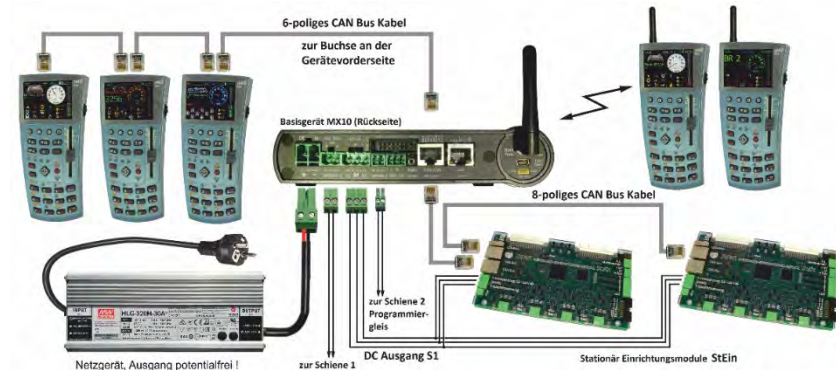

### Alternate minimum setup: Central command station MX10 with Roco multiMAUS:

Roco multiMAUS as initial equipment are a cost-efficient alternative to the controller MX32. Additionally, a combination like this may also be used, when the Roco central station Z21, which was used up until now, is replaced by a ZIMO MX10 central station. This is usually the case, if you need MX10's better performance or other characteristics as HLU.



The wired (red) Multimaus is connected via a corresponding cable to the XNET socket of the MX10 (front side).

Regarding radio contact with the (black) WIFI MultiMAUS: see previous chapter

A bigger arrangement with StEin, computer and various controllers:

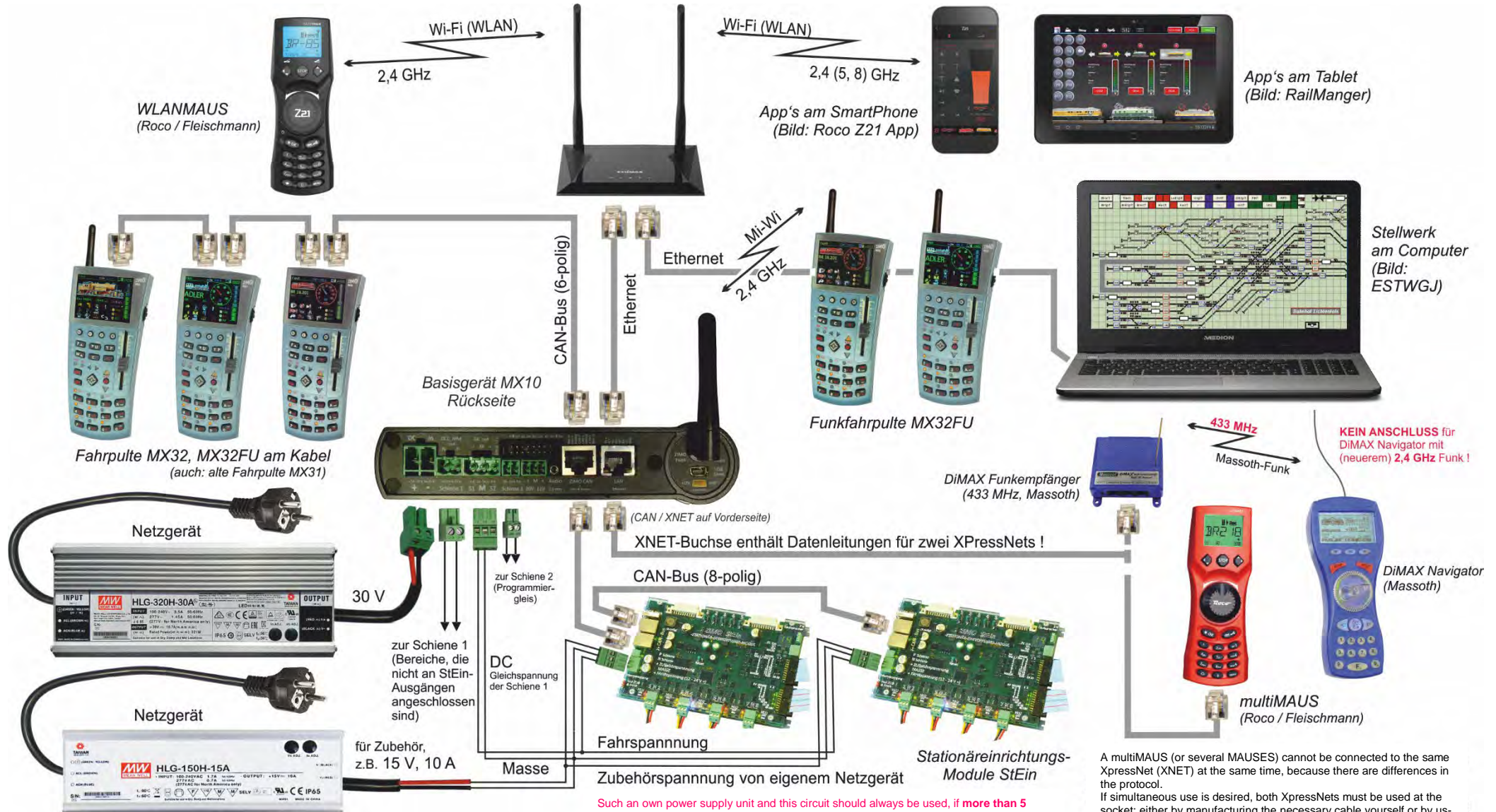

Such an own power supply unit and this circuit should always be used, if **more than 5 StEin modules (with MX10) or more than 1 StEin module (with MX10EC)** are used. Only in smaller applications is it advisable to use the accessory voltage for the StEin (which also covers the internal consumption of the modules) from the "DC-out" output S2 of the MX10 or 12 V of the MX10EC.

A multiMAUS (or several MAUSES) cannot be connected to the same XpressNet (XNET) at the same time, because there are differences in the protocol. If simultaneous use is desired, both XpressNets must be used at the socket: either by manufacturing the necessary cable yourself or by using the "connection and distribution board" MX10AVP (see relevant chapter). See also chapter "The MX10 MENU", item "Bus Config+Monitor".



### 3.3 More voltage & current on the track by... Combining the track outputs of the MX10, or a number of MX10s in a Master-Booster arrangement

SW July 2018 - SW 01.24 and higher

If the "normal" track output of the MX10 ("Schiene 1" (track 1) or "S1" with 12 A traction current) is not enough to supply the layout, frankly, there are two possibilities: interconnecting the two track outputs ("S1" and "S2" with configuring "SYNC" in "MX10 CONFIG") to a power circuit of about 20 A, or the usage of booster devices (specially configured MX10).

*Interconnecting the MX10's outputs (picture on the right):*

The outputs "S1" and "S2" are interconnected (caution with N-P polarity), and together form the connection point for the layout. In the menu "MX10 CONFIG", -> "SYS MODE", "SYNC" is set. This means that all running voltages (only adjustable in combination) and "STOP & OFF" states are automatically set on the same level.

But the track outputs shall not be connected directly, the connecting cable has to have a MINIMUM RESISTANCE of **0.01 Ohm**. This can be guaranteed by a certain cable-length.

- 0.5 m stranded wire with a 0.75 mm<sup>2</sup> cross-section correspond to about 0.01 Ohm
- 1.5 m stranded wire with a 2.5 mm<sup>2</sup> cross-section correspond to about 0.01 Ohm
- 2.5 m stranded wire with a 4.0 mm<sup>2</sup> cross-section correspond to about 0.01 Ohm

Attention: the MAXIMUM resistance shall be **0.1 Ohm** because otherwise the current equalization between the two outputs would no be possible due to the automatic voltage variation. This leads to the recommendation:

**Typical cable between "S1" and "S2": 1 - 2 m long**

**Note:** due to the fact that track 1 and track 2 are equivalent, modules like the StEin can also be supplied by the track voltage of track 2. Still, you have to take the programming track function into account.

#### Master-Booster operation:

Up to 16 MX10 (or MX10EC) can work together as boosters with one MX10 (or MX10EC) as digital command station.

Each MX10, both master (digital command station) and booster, has to be supplied by a potential-free power supply unit. We recommend ZIMO's power supply units of 240 W or 600 W (with real booster operation usually the more powerful one).

In the booster's menu "MX10 CONFIG", -> "SYS MODE", "B1"... "B16" is configured. Each booster device gets its own number. The system central command station keeps the configuration "MASTER".

The boosters are automatically synchronised with track output S1 of the central device; thereby also BCS (broadcast stop) and OFF states are synchronised. As service mode programming track, exclusively track output S2 of the central MX10 (Master) can be used.

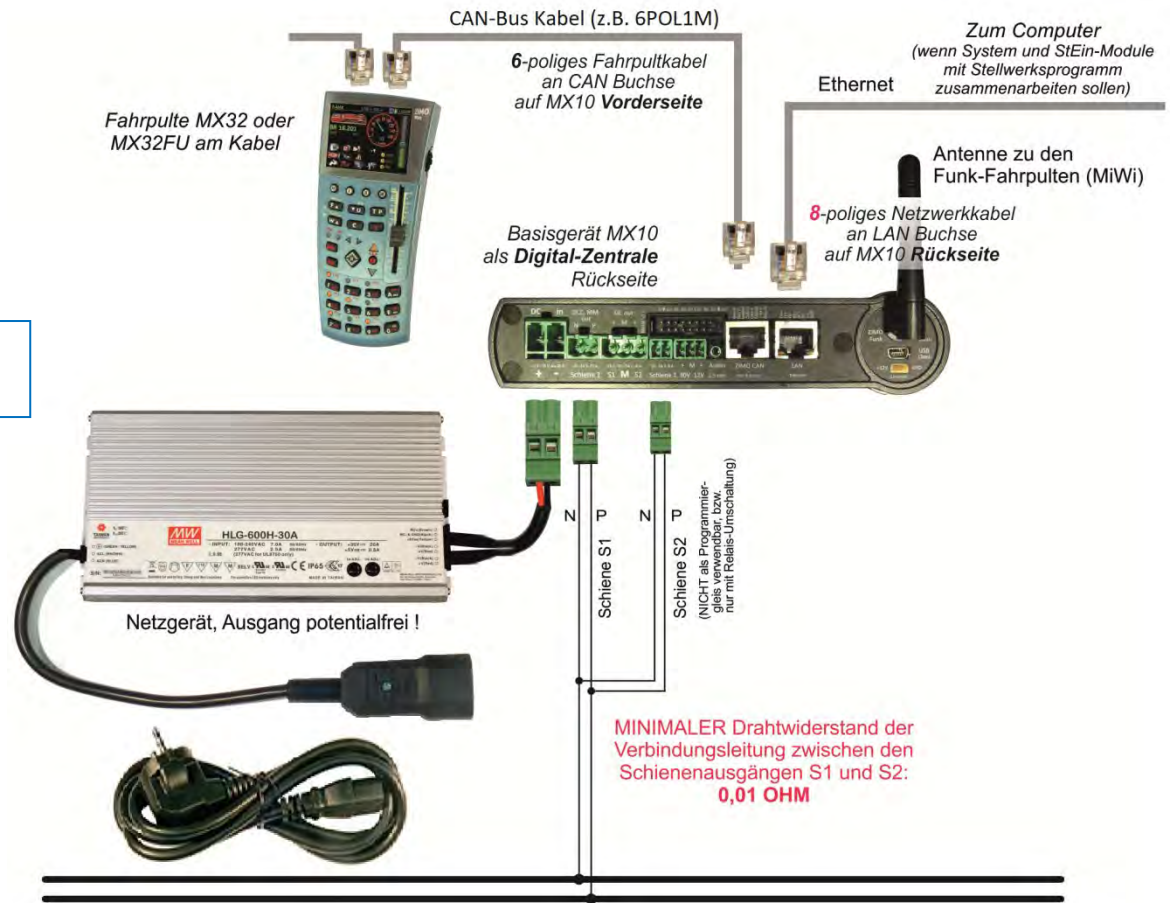



The devices communicate and synchronise via an **8-pole** CAN bus cable (type network cable); for all devices only the CAN sockets on the **device's back** may be used. Due to the fact that there is only one such socket per MX10, you have to use a CAN bus distributor (**8-pole**) for forwarding to a third (...) device.

**ATTENTION:** the 6POLTRIP (4-fold coupler for CAN bus wiring) should NOT be used to wire boosters! For these cases use the MX10AVP-board.

The track outputs of the central device and the booster device shall **not** be connected **directly**: each track output should supply a layout area on its own. Nonetheless, the power circuits are connected when a vehicle

crosses the sectioning point. Therefore, a **MINIMUM RESISTANCE** of **0.05 Ohm** shall be guaranteed for the connecting wires (plus rail resistance). This can be guaranteed easily by certain lengths of wires and rails (whereby the sum of both poles is effective):

- 2.5 m stranded wire with a 0.75 mm<sup>2</sup> cross-section correspond to about 0.05 Ohm
- 10 m stranded wire with a 2.5 mm<sup>2</sup> cross-section correspond to about 0.05 Ohm
- 15 m stranded wire with a 4.0 mm<sup>2</sup> cross-section correspond to about 0.05 Ohm
- 25 m LGB-tracks (each of the two sides) correspond to about 0.05 Ohm

Attention: the **MAXIMUM** resistance shall be **0.1 Ohm** because otherwise the current equalization between the two outputs would not be possible due to an automatic voltage variation. This leads to the recommendation:

**Average cable length between output and track connection: 2 - 10 m**  
**Connection cables > 10m: use at least a 4.0 mm<sup>2</sup> stranded wire!**

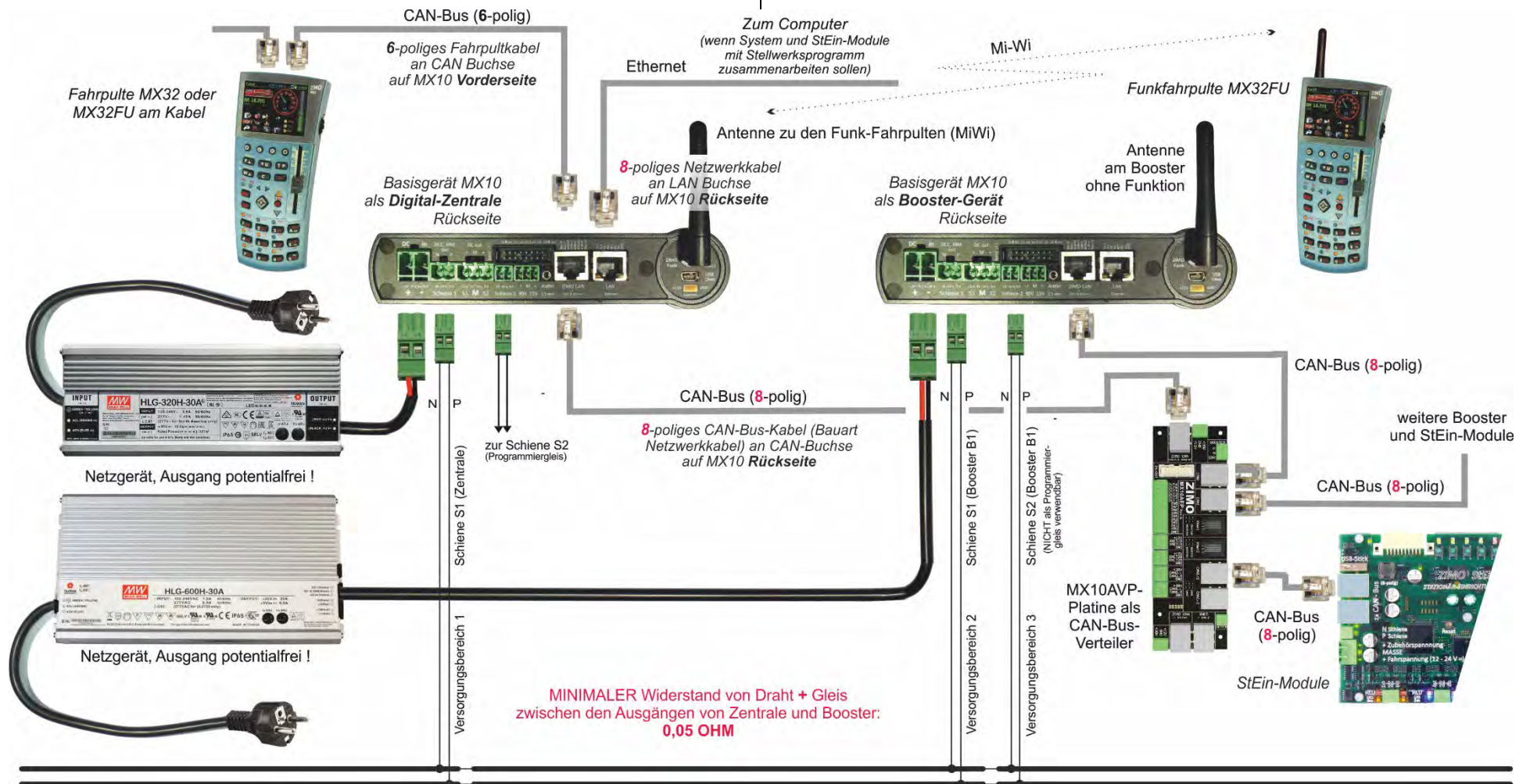

## Connecting old and new ZIMO controllers and controllers of other manufacturers

As controllers you can use various devices that communicate with the MX10 in different ways:

### - ZIMO CAN – “CAN1” and “CAN2”

ZIMO controllers of all generations: MX2, MX21, MX31, MX32 and ZIMO controllers MXFU (to connect the “old” radio controllers MX21FU, MX31FU). But only the current generation (MX32) uses all functions of the MX10. But only the current generation (MX32) uses all functions of the MX10; see notes below!

### - “Mi-Wi” via the built-in radio module in the MX10

communicates with the current generation of ZIMO controllers (MX32FU and MX33FU), which also have a built-in “Mi-Wi” radio module. “MiWi” is a radio module of the company Microchip, which is based on the same hardware as the better-known “ZigBee” standard.

### - XNET

The “red” Roco Multimaus and Massoth DiMax Navigator communicate via “XPressNet”, the ZIMO-called “XNET”. The actual XNET connectivity of the MX10 with products other than Roco and Massoth are NOT tested.

### - WIFI (MX10 connected to a router via the LAN socket)

for mobile phones and tablets with WIFI, or apps on these devices (e.g. Roco Z21 App), and for other mobile devices (e.g. Roco WIFI Multimaus).

### - Bus systems of other manufacturers: LocoNet and S88

These interfaces are available on the hardware, but not (yet) working. The future implementation depends on the demand.

### - USB client interface:

Computer controllers within interlocking and decoder configuration software like STP, ESTWGJ, Train Controller, PfuSch, etc. most of the time connect via USB or LAN (Ethernet).

### - Sniffer input:

Here you can connect the track outputs of third-party systems to transmit the produced data to MX10’s outputs. This interface is available on the hardware, but not (yet) working. The implementation depends on the demand.

### **The ZIMO CAN bus also called “CAN1” bus - on the sockets ZIMO CAN**

The central command station MX10 has two 8-pole sockets for the CAN bus, one on the front and the second one on the back of the device. The 6 pins in the middle of the two sockets which form the so-called ZIMO CAN are completely identical, and internally connected in parallel. This means that all devices connected to the CAN sockets are also electrically connected in parallel.

The difference between the two CAN sockets only refers to the outer pins: The socket on the back has an additional wire to synchronise the control signals of the StEin modules; whereas the socket on the front transforms to a sniffer input, in case an 8-pole cable is used.

Each controller (MX32, MX32FU, MX31, ...) is equipped with two equal 6-pole sockets, which allows daisy-chaining power supply and data from one controller to the next. An alternative would be a 6-pole ring feeder with sockets and distributors, to which controllers can be connected if needed.

RailCom® is a registered trademark of Lenz Elektronik GmbH

### “CAN2” - bus

Additional to XNET itself, connections for “CAN2” are available in the “XNET” socket. This is needed in case “new” products MX10, MX32 are used in combination with “old” controllers like MX31, or accessory and track section modules MX8, MX9.

In case MX32 or MX32FU are used in combination with “old” controllers MX31, MX2, MX21 or radio modules MXFU the wiring has to be the following:

- The “old” devices (MX31, ...) have to be connected to one of the two CAN sockets with a standard CAN bus cable, either in the front or the back.
- The “new” devices (MX32, MX32FU) have to be connected to the XNET socket (!) with the **special cable “8POLAxM”** (8-pole plug on the MX10’s side, 6-pole plug on the controller’s side). This special cable connects the “CAN2” connections of the XNET socket to the CAN connections of the controller.

It is necessary to use both CAN buses, because there is a new, faster protocol between the “new” MX32, MX32FU and the MX10, which the “old” devices are not capable of. As soon as there is one device in the system circuit that operates with the old CAN protocol, the MX10 switches to “MX1 operation”. This leads to limitations in the ZIMO CAN circuit. Like for example no RailCom, 12 functions, ...

To retain all functions of the MX32, it has to be connected to the ZIMO CAN2 (XNET) socket. There are no limitations in the radio operation.

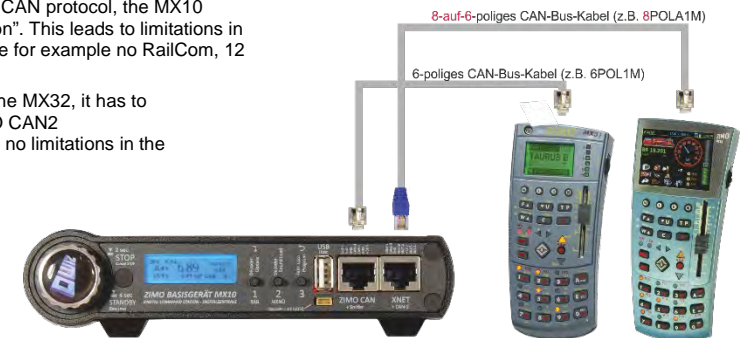

This wiring is also important, when working with **MX8 and/or MX9**. These modules are connected like a MX31 to the “normal” ZIMO CAN, and the MX32 are connected to the “CAN2” on the XNET socket, as described above.

### Radio communication via “Mi-Wi”

The MX10 and the ZIMO controllers MX32FU are equipped with a radio module of the company Microchip, who also manufactured the “PIC” microcontrollers.

The “Mi-Wi” protocol is a derivative of the “ZigBee” standard, and therefore 2.4 GHz, but with higher efficiency and lower resource consumption. Compared to bluetooth, which also has 2.4 GHz, Mi-Wi has a bigger range of up to several 100m. In contrast to WIFI, Mi-Wi has an integrated “Mesh” networkability.

Compared to the 344 MHz technology of the “old” ZIMO controllers, Mi-Wi has a higher throughput and worldwide approval.

Potential downsides of the 2.4 GHz technology compared to the 344 MHz concerning the penetration ability inside buildings can be balanced on the one hand by the networkability, and on the other hand, 900 MHz Mi-Wi modules can be used (instead of 2.4 GHz) if needed.

**Massoth DiMAX Navigator on the MX10**

DiMAX Navigator controllers can ONLY be operated as radio modules. Therefore the DiMAX radio receiver (e.g. "model for XpressNet & LocoNet, MS8130101) is connected to the XNET socket of the MX10.

*Attention: There are differently built radio receivers with the same name and type number - only the newer (current) version is working in this instruction manual. Unfortunately, this is only possible opening the device.*

A DiMAX radio receiver has 3 connection sockets. Connect the socket in the middle named "XPRESSNET" via a 4-pole standard XpressNet cable or a 6-pole ZIMO CAN cable to the "XNET" socket on the central command station MX10. Using a ZIMO CAN cable, the outer two wires are not used.



With Massoth devices there is no handover/takeover procedure as with ZIMO. The MX32 shows in the upper bar the note "XNET control", in case another device controls the train via XpressNet. In this situation, the changes made by DiMAX concerning speed steps or function keys, are shown on the MX32. The MX32 can control the address active on the DiMAX immediately, without takeover.

**ATTENTION:** In case a third-party controller (not ZIMO) is connected to the MX10, the parameters for STOP & OFF have to be changed in the MX10 menu: when pressing the STOP key, both track outputs (1 + 2) have to be switched to broadcast stop.

**The ROCO MultiMAUS on the MX10**

The ROCO MultiMaus is connected via a "normal" 6-pole CAN cable to the XNET socket on the MX10. If MX32(FU) are used additionally, those are connected to the ZIMO CAN or operated via radio. The MX32's function is not changed, as far as no MX8 and/or MX9 modules are connected additionally to the MX10's CAN. If this is the case, the MX32 run in the "old" CAN protocol and therefore in the "MX1 operation" which only supports 12 functions and turns off RailCom.

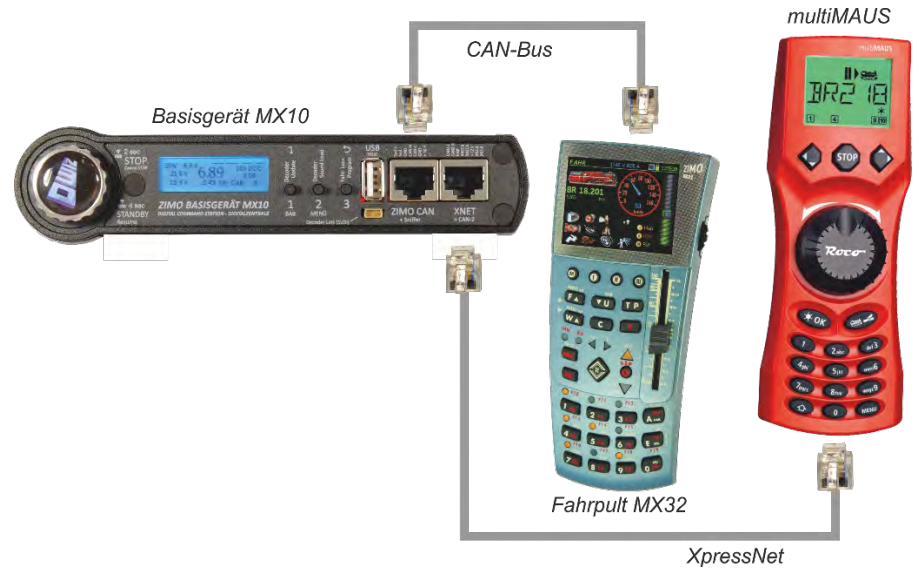

If MX8 and/or MX9 shall be used in this constellation and the MX32 shall retain all their functions, you have to use an adapter for the XNET socket, which also hosts out the CAN2. Such an adapter can be manufactured by ZIMO [service@zimo.at](mailto:service@zimo.at) on request. This is also valid for all other controllers operated via XNET, which do not give access to the CAN2 socket.



## 4. The "Connection and distribution board" MX10AVP

This PCB is available as accessory to the MX10; NOT included in the start sets.

The "Connection and distribution board" MX10AVP is a connector board with comfortable sockets and clamps, which does not have functionality on its own (i.e. no active electronic components).

The MX10AVP is useful, because the MX10 has a lot of connectors, but the space on the front and the back of the device is limited, which is why some connectors are combined into one connection point, like for example: "CAN 2" (the second CAN bus) is on the "XNET" (=XpressNet) socket. For switching rails and similar there are space-saving pin connectors available on the MX10.

The picture on the right shows the typical

Connection between the central command station MX10 and the "Connection and distribution board MX10AVP" with the cables and connectors supplied. Depending on the use, not all of these connections are necessary all the time.

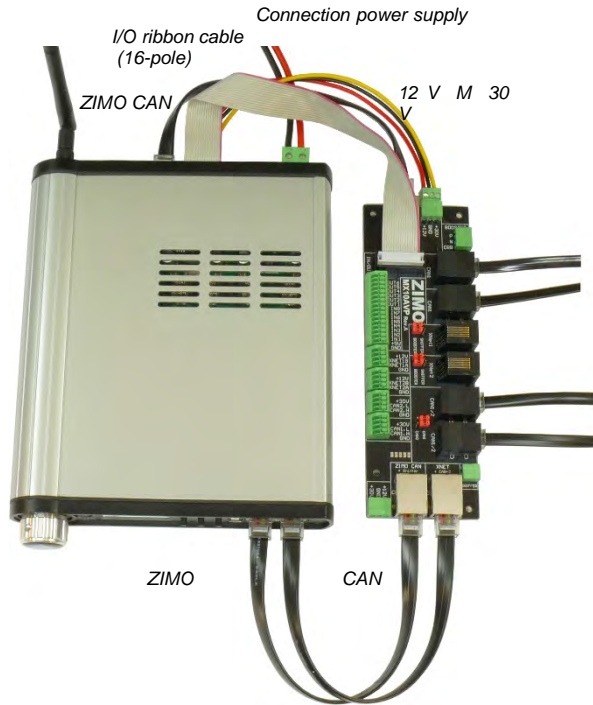

### First Example:

The easiest way to use the "Connection and distribution board MX10AVP" is with a **bus distributor**: while the central command station MX10 itself has two CAN sockets (front and back), this way 5 sockets are available, 4 of them on the MX10AVP. This may be useful despite all devices having two CAN sockets (for daisy-chaining).

In the MX10 menu "Bus Config+Monitor" "ZIMO2.xx (125)" has to be configured for "CAN1" and "CAN2". The MX10AVP's **jumper**s (next to the sockets CAN 1/2) have to be plugged into "**CAN-1**". This way, all 4 CAN sockets are connected in parallel.

As long as the CAN bus only connects controllers of the current generation (like MX32), it doesn't matter if the cables of the connection and distribution board MX10AVP to the central command station MX10 have 6 or 8 poles. For standardisation reasons, 8-pole cables are recommended. To connect the controllers, usually 6-pole cables are used (more flexible).

**ATTENTION:** only use "normal" 8-pole (or 6-pole) CAN cables with the MX10AVP, no "8POLAxM" special cables!

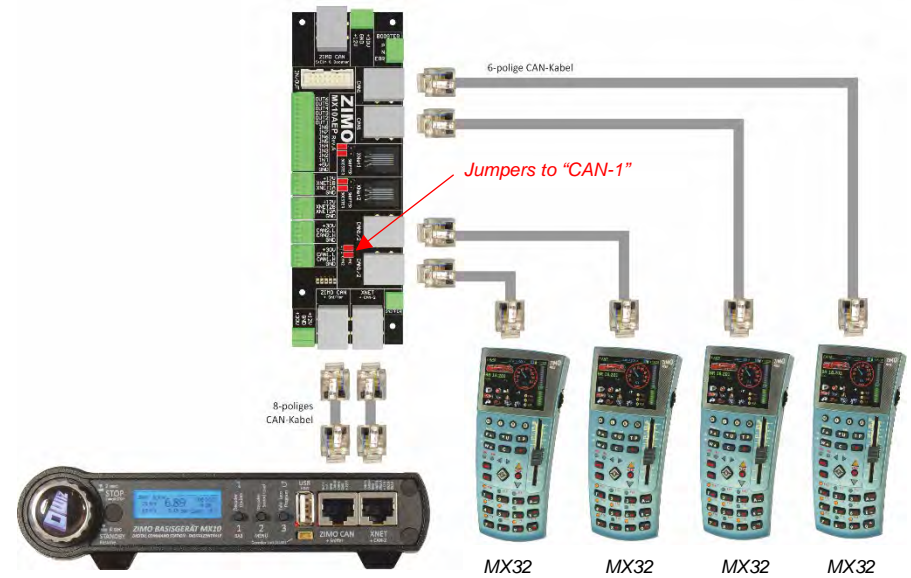

### Second Example:

New (MX32, MX32FU) and old (MX31, MX31FU) controllers shall be used together; the new generation devices communicate via a different protocol than the old ones (at least if full functionality shall be preserved): therefore, in the MX10 menu "Bus Config+Monitor" "CAN1" has to be set to "MX8/9" and "CAN2" to "ZIMO2.xx (125)":

the old controllers (latest: MX31) are connected to CAN-1, the new (MX32) to CAN-2!

The sockets, to which MX32 controllers are connected, have to be set to "**CAN-2**". Set the **jumper**s on the MX10AVP accordingly!

The advantage over a direct connection to the MX10 (with the "special" cable 8POLA1M for the MX32) is the controller's supply by the full "CAN voltage" of 30V when charging the radio controllers.

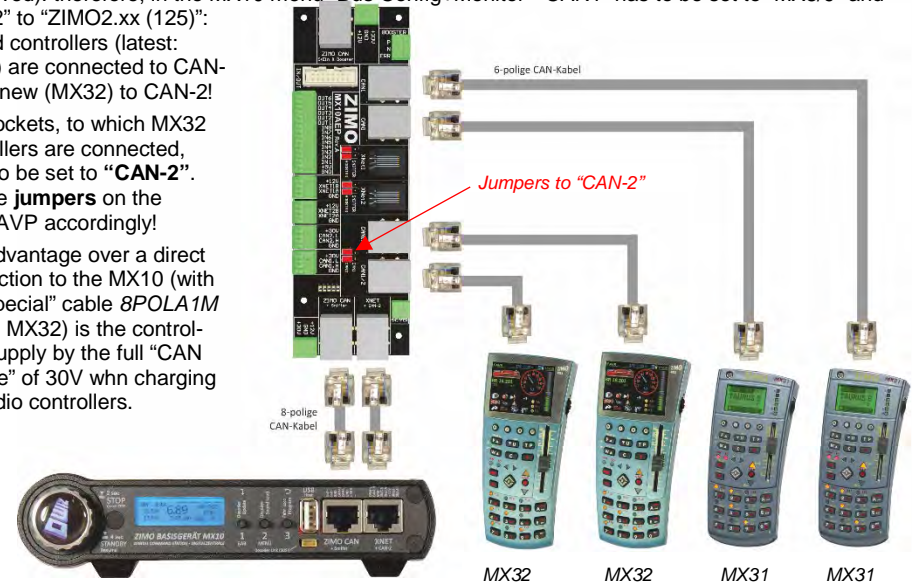

**Third Example:**

In this case, only devices of the new generation are used, controllers MX32 and StEin modules; all work on "CAN1". Due to the fact that StEin modules (as well as booster MX10) need timing information for the DCC track signal, additionally to the actual CAN data bus, wherefore 8-pole CAN cables are needed. Those can be connected either

- from the back of the MX10 to the corresponding socket on the MX10AVP, or
- from the MX10AVP to the StEin modules themselves.

The jumpers (at the best all 4 of them) have to be put on the position "Booster" (not "Sniffer"), so the PCB can forward information and signals.

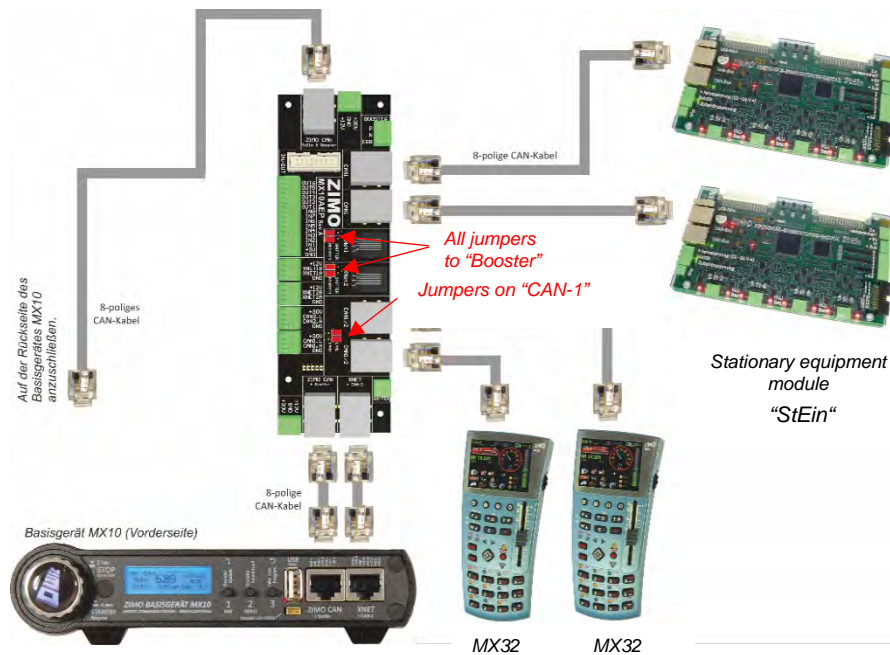

Further devices and modules can be connected via the second parallelly connected CAN sockets on the devices themselves. For example MX32 and "StEin" combined (the MX32 forwards all 8 poles of the CAN bus, although they themselves only use 6).

**Fourth Example:**

In case old and new generation devices shall work together, two separate CAN buses are used. This is the same as using MX32 and MX31:

- old controllers (until MX31) and all accessory and track section modules (i.e. MX8, MX9 with valid addresses 801-863 or 901-963) on CAN-1
- new controllers (MX32, ...) as well as StEin modules on CAN-2.

The sockets, to which MX32 controllers and stationary equipment modules "StEin" are connected, have to be set to "CAN-2". Set the jumpers on the MX10AVP accordingly!

In the MX10 menu "Bus Config+Monitor" configure "ZIMO (MX8/9)" for CAN-1, "ZIMO 2.xx(125)" for CAN-2.

In case CAN power modules are used, they switch on after the MX10 finished starting up.

To compensate the ground in the system, connect MX8 and MX9 to the ground connector on the back of the MX10 (DC out "M").

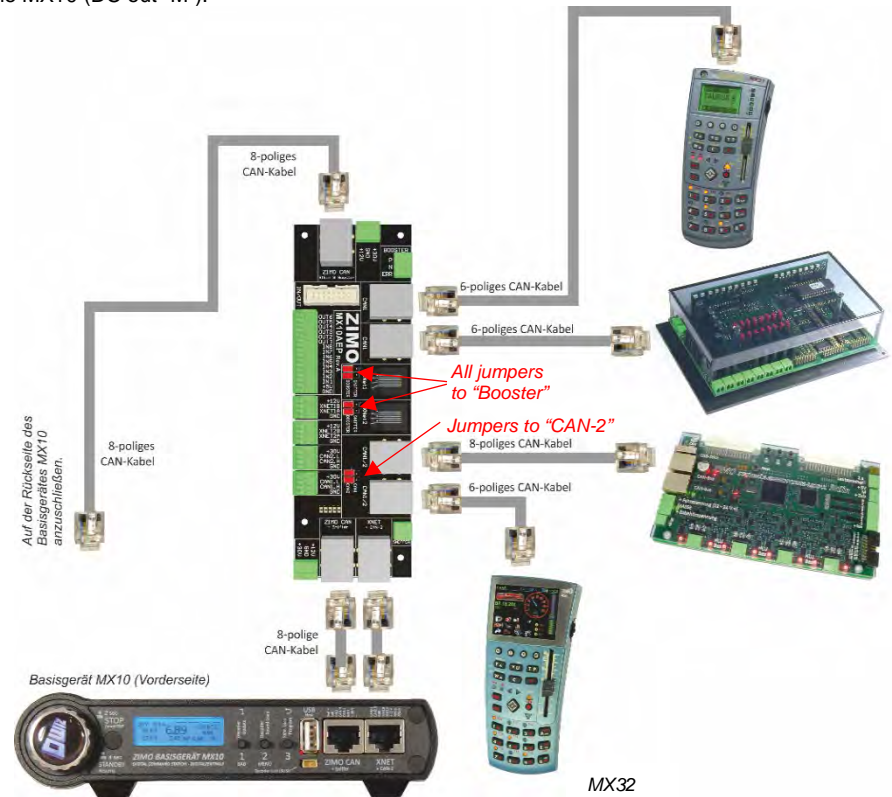

**NOTE:** as soon as one MX9 is connected, RailCom is deactivated on the whole layout. Also see chapter "Menu points DCC signal settings"



**Further applications:**

Additionally to or instead of the CAN bus applications described above, the connection and expansion board MX10AVP is also used:

- as connection to XpressNet devices: Roco Multimäuse or DiMAX Navigator radio receiver. The ZIMO central command station MX10 supplies two Xpress networks, which are combined in one socket ("XNET"); MX10AVP has separated sockets "XNET-1" and "XNET-2" (between the CAN sockets).
- to comfortably controlling (via spring clips) the 16-pole pin connector on the MX10, i.e. 8 inputs (for contact rails, emergency stop keys, etc.) and 8 outputs.

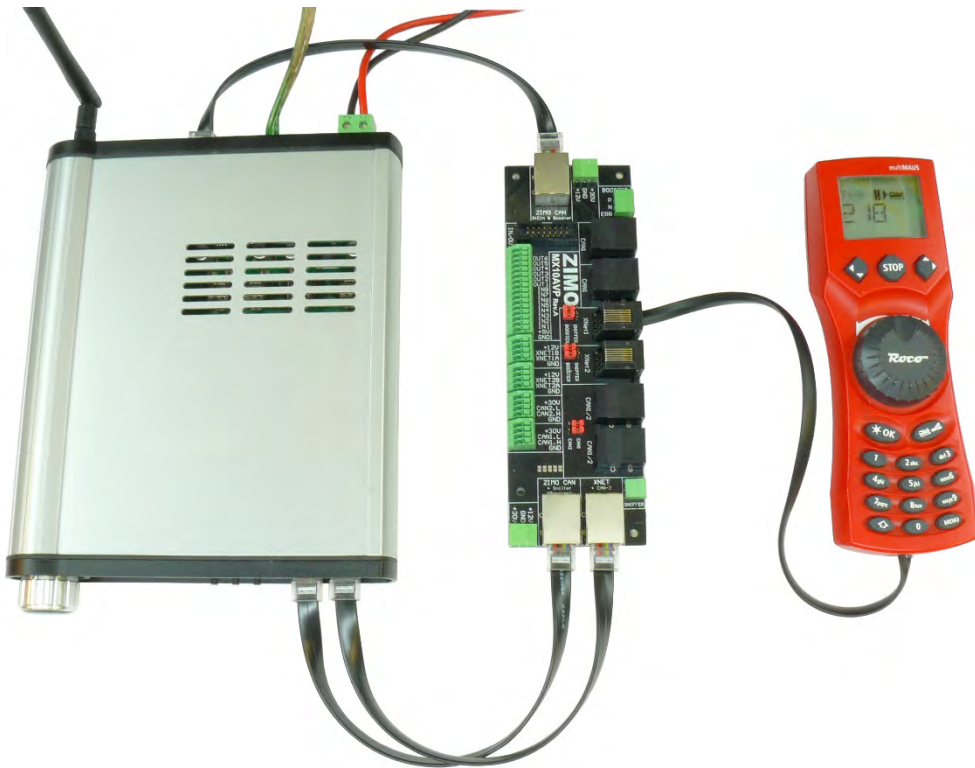

*Connecting a Roco Multimaus via a 6-pole cable to an XNET socket on the MX10AVP.  
(of course you would not need a connection and expansion board for just one Multimaus,  
but in combination with one of the cases described above, this kind of connection is useful).*

## 5. Rail connections, programm. track, AOS in/out

The central command station MX10 is equipped with two rail connections, MX10EC only has one output:

- the output “Schiene 1” (track 1) - usually to connect the “main track”, i.e. the actual layout
- the output “Schiene 2” (track 2) - sometimes used as additional power circuit (with separately adjustable voltage, maximum current, etc.) or

as **programming track** (addressing and programming decoders in service mode, called *SERV PROG*), and as **updating track** (to update decoders and to load sound into the decoders).

“Schiene 2” is completely fit for traffic, if it is not occupied by a programming, updating or sound loading task. It has the same track signal as track 1. If track 2 is used as programming track which is accessible from the main track, it has to be insulated completely from the main track. Because the train passes the sectioning points between track 1 and track 2, the polarity (N & P clamps) has to be the same on both tracks.

- MX10EC provides the output “Schiene” for the main track and also for the programming track - depending on the situation.

The running voltages on the track outputs generally can be adjusted individually, see chapter “Main settings”.

each **10 - 24 V** - (see chapter “Application...”) and are fully stabilised.

The limitations:

- Track 1: **1 - 12 A** and
- Track 2: **1 - 8 A** - as well as

the turn-off times  
- **0.1 - 5 sec** each - (e.g. to bypass short circuits on Frogs)

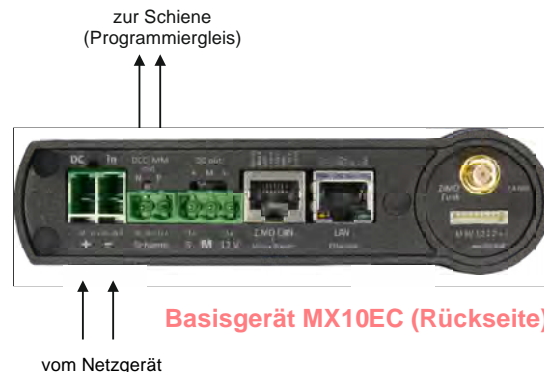
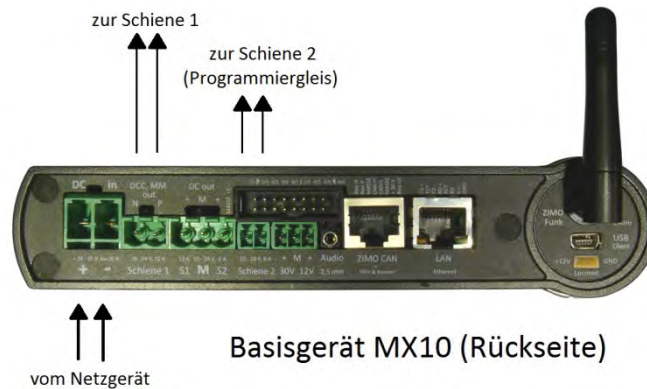

**NOTE:**  
“Side effects” due to high track current are kept low in the MX10 and MX10EC by special measures:  
High frequency-sliders for track outputs with low output capacity prevent high energy peaks.  
The spark suppression function developed by ZIMO (adjustable in three steps) suppresses occurring light bows.  
- The special configuration “adaptive over-current detection” defines an overcurrent shutdown due to a sudden current increase, also when the actual overcurrent threshold is not yet reached.

### Voltage and maximum current on the programming track in SERVICE MODE (SERV PROG):

By default, the voltage and current values on the programming track are automatically set to 11V and 0.3 A (maximum current at the beginning) or 0.1 A (maximum current after 100 msec) after entering in service mode -

usually with a controller by pressing E-key + MN-key. This corresponds to the standard published by Railcommunity (European association of manufacturers of digital model railway products).

The idea behind these rigid current limits when programming is to prevent damage to vehicles and electronics, even if for example a decoder is wired incorrectly. Nevertheless, not all vehicles are designed to actually consume such a low amount of power. On the one hand, there are capacitors that need to be charged, and on the other hand, the locos contain consumers which are not connected to the decoder and therefore cannot be turned off.

Therefore the possibility to change this default configuration of voltage and current exists; this is done in:

MX10 main menu → VOLT & AMP DETAIL → SERV: Running voltage, maximum current

The controller shows a WARNING on the SERV PROG screen, if the SERV PROG configurations deviate from the standard described above.

### Using an external programming track relay:

In case the “track” is used as part of the layout and as programming track, (at the MX10EC if Service Mode shall be used at all) you can switch either manually or by relay, which is more comfortable.

The relay is therefore connected - as shown in the graphic - to the 16-pole pin connector between the pins “5V” and “out-6” (at the MX10EC between “5V” and “out-2”) The relay has to be a type with two switching contacts which have a minimum load capacity of 5 A, at the best of 10 A.

The MX10 automatically switches the relay, so that it connects “Schiene 2” to the programming track, while a controller (and therefore the connection point “Schiene 2” or “Schiene”) is in operation state *SERV PROG*. Otherwise the connection “Schiene 2” or “Schiene” is connected to the programming track, while otherwise it is connected to the layout.

**NOTE:** This is the standard use of the “out-6” pins. Nevertheless, this standard can be changed (see for example: menu point DCC SERV PROG configurations); be as it is, the use as programming track relay would not be available.

**MX10EC:**  
“out-2” pin for the programming track relais (to “5V” pin)!

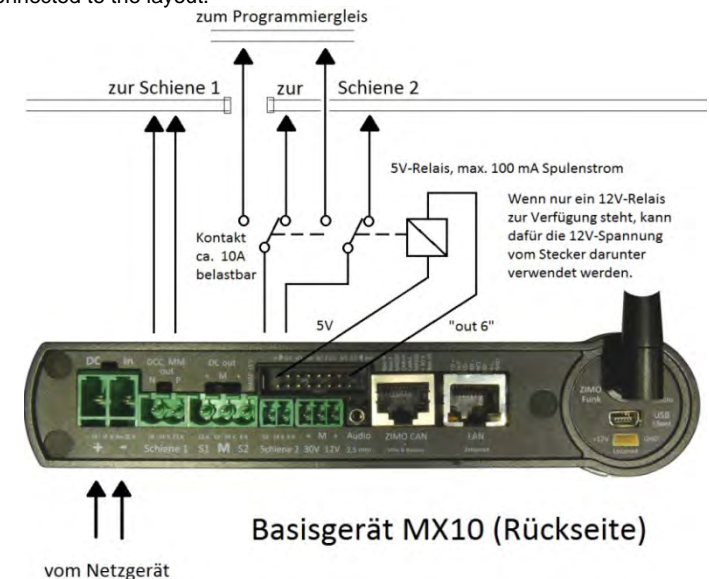



**The MX10 as decoder update device (planned):**

It is one of the basic tasks of a modern digital command station to support loading new software or sound into the decoder. Therefore - at least for ZIMO decoders - no extra updating and sound loading devices are needed (but still available - from ZIMO in the form of the MXULFA).

Loading new software or sound can be done directly via a connected flash drive or via the USB interface (from the computer). The MX10 has the capacity of storing several decoder update collection files or sound projects in its own flash memory and using them if needed.

**Connecting external emergency stop buttons:**

The AOS inputs (1 to 8) on the 16-pole pin connector can be used for different tasks, especially for AOSs (automatic operation sequences).

By default, the inputs "in-5" to "in-8" are set to "report". To these inputs, emergency stop buttons can be connected. For this, there are 8 possibilities. Most of the time, you probably need to activate BCS (broadcast stop) on track 1 - an emergency stop button for this case has to be connected to "in-7" and for its activation connected to the system's ground (ground accessible on the 16-pole pin connector or on screw terminals).

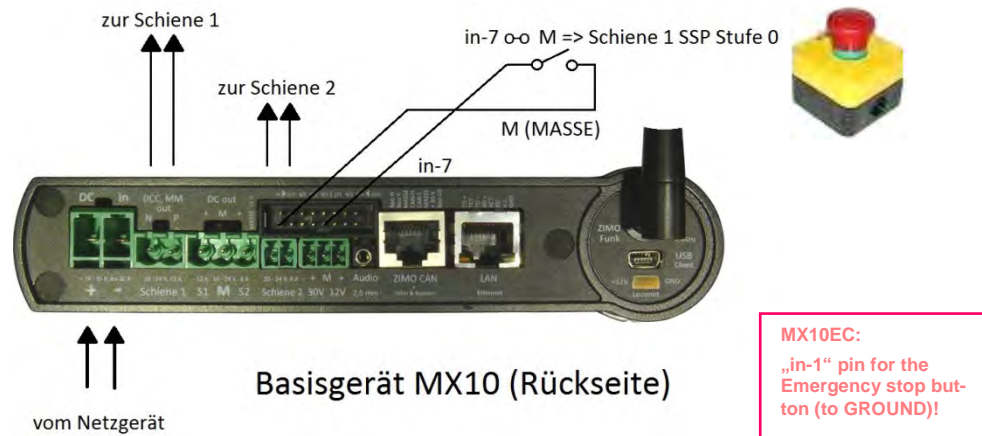

**MX10EC:**  
„in-1“ pin for the Emergency stop button (to GROUND)!

Configuration of the AOS inputs see chapter 8.8, the MX10 menu, menu point AOS in/out Monitor+Config.

**Broadcast stop and OFF with the MX10 central command station:**

In case of a broadcast stop, the BCS notification is displayed on the MX10 and each connected (tethered or via radio) controller. The operation can only be resumed ("ON") from there.

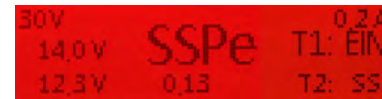

Display MX10



The graphic beneath shows all possible emergency stop connections, to activate either BCS (broadcast stop) with Emergency or speed-step-0 \*, or track-OFF separately for "track 1" or "track 2".

\*BCS (broadcast stop) with Emergency means an immediate stop without braking distance (depending on motor and gearbox it has low to no coasting, may lead to derailment), speed-step-0 stops the trains with the deceleration times configured in the decoders (CV #4).

**MX10EC:**  
**NOT possible due to lack of inputs.**

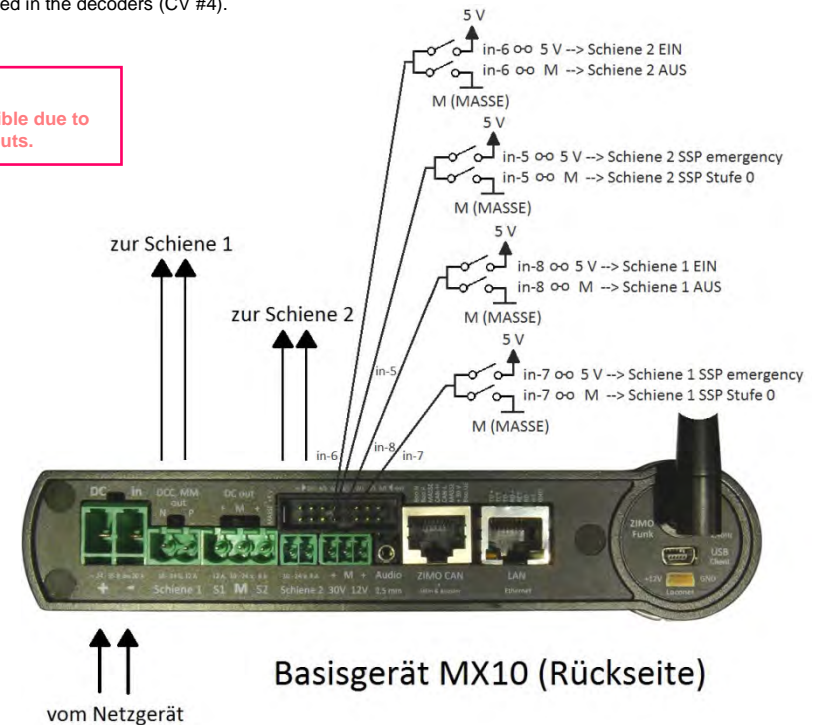

**NOTE:** in software versions, in which this function of the AOS inputs is not yet available, the wire "Boo UE" on the ZIMO CAN socket can be used for the external emergency stop.

## 6. Track signal, Feedback, Database

DCC and MOTOROLA (MM) form the basic equipment of the MX10. Nevertheless, hardware and software are open for expansion to other protocols, especially mfx (with RDS-feedback) and Selectrix, if demanded. It would also be possible to expand to new, more efficient methods (as the currently existing formats) of data transmission on the tracks.

**NOTE:** Motorola (MM) is NOT YET implemented in the current software (on which this instruction manual is based).

### **RailCom® and ZIMO loco number identification:**

The "bi-directional communication" corresponding to "RailCom®" is an essential component of all relevant devices of the ZIMO system (of the generation MX10 / MX32 / StEin).

The MX10 is equipped with two „**RailCom®-precision global detectors**“, i.e. one detector per track output.

"Global" is a term of the RailCom® standard (already since the NMRA) and means that it receives RailCom® notifications independent of the locos position (=track section), e.g. feedback about speed, current consumption, alarms, turnout positions, CV values, etc. \*).

"Precision" means that RailCom® notifications are not acknowledged by the standardised thresholds, but that the RailCom® signal is digitalised first and then analysed, to be able to read very low and mutilated notifications and also, to be relatively insensible towards influences as they occur in almost every extensive layout, especially by the consumption of a big part of the RailCom® signal by illuminated wagons.

\*) "local detectors" on the other hand identify the vehicles on the single track sections; within the ZIMO system this task is done by the "StEin" modules (stationary equipment modules); but those are not only simple local detectors, but also read global notifications (and forward them to the MX10), because on a big layout, the receiving quality can be much better on a single track section than on the command station's position.

The central command station MX10 also reads the "loco number impulses" of the decoders, because they are used in addition to RailCom® as acknowledgement for the reception of DCC packets, also of decoders which were produced before 2005 when RailCom® did not yet exist, but only loco number identification as feedback from the decoders.

**ATTENTION:** While processing programming and reading commands in SERV PROG (track 2 as programming track) NO RailCom® messages can be received (neither on track 1 nor track 2). This does NOT refer to the time the controller is in SERV PROG, but only the short time of the acknowledgment.

### **Organising data transmission via track signal (DCC or MM)**

(in many documents also called "transmission cycle"):

Additionally to supplying the layout with traction current, a digital command station has to assume the relevant information for the vehicles and accessory decoders from the input devices (controller, computer, ...) and forward them efficiently, i.e. with the least possible delay and highest possible reliability to the decoders.

Thereby the vulnerability of the data canal due to the contact disruptions between track and vehicle has to be taken into account, which is a common factor in the model railway world.

This is why a complex priority schema is used, which decides how the available transmission time is distributed to the different current data packages. The following levels are differentiated; high priority (order 0, 1, 2, ..) means more frequent transmission:

0. Protocol requirements (Request-for-Service-Slots, time synchronisation for decoders, etc.)
1. Changing data contents (new velocity, functions, etc.) by controller, computer, or others.
2. Data for addresses in the controller's foreground,
3. Data for addresses of "secondary objects" of the addresses in the foreground, e.g. consist,
4. Data for addresses of computer controllers (ESTWGJ, STP, TrainController, etc.),
5. Data for addresses in the controller's LoR, or the favourites in the computer,
6. Data for addresses in the system database (which is not one of the higher priorities)
7. Scan cycle, to find not reported addresses.



## 7. MX10 update, data import and storage

### The current software version:

You can download it for free from our website:

www.zimo.at → "Update & Sound" → "Update System (MX10, MX32, ...)"

Starting with software version 01.17, a so-called "Container-File" is used for MX10 and MX32(FU). This Container File contains all necessary files for the update of both devices. This way, only one file has to be downloaded and stored on the flash drive.

**The currently loaded version (incl. current software versions of the radio processors and XILINX) can be called up in the MX10's menu.**

Press **button 2 (MENU)** → screen **GREY: MENU for operating the MX10**

⤴ Positioning the cursor (▶) with the rotary knob on "MX10 Config", press=select

⤴ Positioning the cursor (▶) with the rotary knob on "Version-SW..."

**Button 3 (↵)** press three times → back to normal screen **BLUE**

### The necessary flash drive:

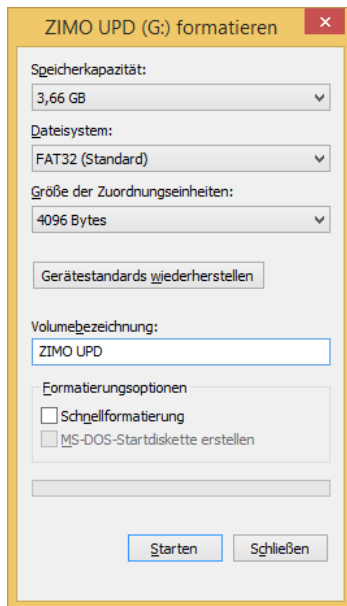

As shown in the window on the left, the flash drive has to be formatted in the filesystem **FAT32** to update the MX10. The Cluster size shall be set to **4096 Bytes** (= 4kB).

The standard flash drives are already formatted this way by default.

If you use an older or differently formatted flash drive, untick the point "fast formatting" when formatting for the first time.

If the right flash drive is found, the software update can be stored on it. It is very important that the update is saved in the root directory, because the MX10 cannot look into folders. The ".zip" file which contains the software update has to be unzipped before it can be used.

You do not need a special flash drive especially for the update, other files do not disturb the updating process.

*These characteristics are also valid for the update of the MX32(FU)!*

**ATTENTION:** Flash drives bigger than 32GB cannot be formatted to FAT32 in Windows 7.

### The updating process:

The MX10 software update is done during operation. If a flash drive with the usable files is connected, **all outputs on the MX10 are switched off**. All devices which are supplied by the MX10 are therefore without current. To prevent damage to the vehicles, it is best to stop all operation on the layout before the flash drive is connected to the MX10 and therefore all current is shut down.

Screen in normal operation **BLUE**

The flash drive with the software is connected to the USB socket.

↔ (flash drive)

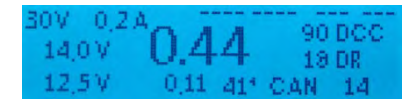

The MX10 reads the flash drive automatically, → on the update screen **TURQUOISE** all found files are listed:

Available and therefore selectable positions of the flash drive are shown in "**BOLD**". The other points are files which generally can be loaded into the MX10 but are NOT available on THIS flash drive, or cannot be found by the MX10.



"MX10 Update (all)" includes:

- Main processor MX10 update
- Radio processor update
- XILINX update
- Language (DE, EN)
- CV list
- Decoder denominations
- MX10 sounds (e.g. Error)

⤴ Positioning the cursor (▶) with the rotary knob on "MX10 update (all)"

⤵ Press rotary knob → The screen changes to **RED** colour, version number and creation date of the MX10 update are shown.

⤵ Press rotary knob (again) → run software update. After finishing, (about 10 sec) the MX10 displays the next step.

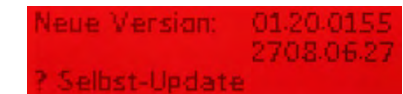

**NOTE:** In case the rotary knob is turned instead of pressed, or another key is pressed, the update process is cancelled immediately and the MX10 changes to normal operation. In this case, unplug the flash drive and plug it in again.

**After each update, the MX10 has to be disconnected from the power supply and restarted after about 1 minute, to make sure that all concerned circuit elements are started with the new software.**

In case there is no usable file on the flash drive (corrupted, damaged) or it is empty at all, a note is shown instead of the list (also **TURQUOISE**:

"NO ZIMO FILES FOUND"

can be read. In this case, the flash drive has to be unplugged and checked for an available (or usable) update. When the flash drive is unplugged, the MX10 automatically changes to the normal screen (without restart) **BLUE**.

## 8. Usage and operating elements

When connected to a power supply unit, the MX10 automatically starts with a booting sequence, which takes a few seconds.

The boot screen **RED** shows a booting protocol. If the MX10 is connected to the LAN and has a valid IP address, the screen shows "LAN link active". If it is connected via USB port, it shows "VCom Link active".

In case the MX10 is connected to the LAN and via USB port, the LAN prevails - **USB therefore is inactive!**

After the booting sequence, the MX10 changes to the normal **BLUE** screen. It shows the currently measured voltage and current values on both track outputs as well as some communication data (DCC, CAN,...). The very big number (in the middle) shows the current current consumption on track 1.

Depending on the configurations for START UP CURRENT and START UP TIME (see "voltage and current configuration"), the voltage is started up faster or slower, which, in turn, depends on capacitors in the vehicles that may be loaded. The start up process can be observed on the screen.

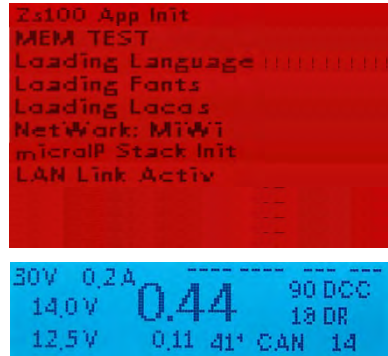

### 8.1 The normal screen on the MX10

**AOS inputs/outputs**, shows the status of all 14 connections.

**Voltage and current on Input "DC in"**, i.e. of the Power supply unit, which Supplies the MX10 and the whole layout („Primary supply“ \*).

**Voltage and current on Output track 1:** (DC output S1 included).

**Voltage and current on output Track 2** (DC output S2 included).

**Track signal statistics** (number of sent command packets per sec);  
xx DCC = only DCC packets  
xx MM = only MM packets  
xx/yy D/M = DCC and MM

**RailCom - statistics** (number of received notifications as feedback to DCC commands).

**CAN Bus - statistics** (number of CAN packets);  
CAN xxx E = number of CAN packets per sec \*\*  
C xxx E yy% = number and percentage of errors

**Measured temperature of the PCB** (Celsius)

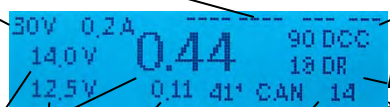

\*) The power indicator for the "DC-in" input (power supply unit) is not determined by measurement, but derived from the output currents (track outputs 1, 2, as well as the 12V and 30V outputs and the internal consumption of the device) taking into account the efficiency of the voltage converter. This is especially relevant when estimating, if the power supply unit still provides enough power reserves.

\*\*) Sporadic flaring-up of the letter "E" shows singular errors on the CAN bus, which can occur when plugging in/unplugging devices, but they usually do not make problems. With more than

10 errors per second, the screen switches to "E" with the percentage of the received damaged packets (in relation to the overall number of packets that are displayed behind "C"); if the percentage is a few percent or higher, this may point to bad transmission quality on the CAN bus (e.g. because of long, badly connected cables).

### The normal screen on the MX10EC

**AOS inputs/outputs**, shows the status of all 14 connections.

**Voltage and current on Input "DC in"**, i.e. of the Power supply unit, which Supplies the MX10 and the whole layout („Primary supply“ \*).

**Voltage and current on Output "track 2"** (DC output S included).

**Track signal statistics** (number of sent command packets per sec);  
xx DCC = only DCC packets  
xx MM = only MM packets  
xx/yy D/M = DCC and MM

**RailCom - statistics** (number of received notifications as feedback to DCC commands).

**CAN Bus - statistics** (number of CAN packets);  
CAN xxx E = number of CAN packets per sec \*\*  
C xxx E yy% = number and percentage of errors

**Measured temperature of the PCB** (Celsius)

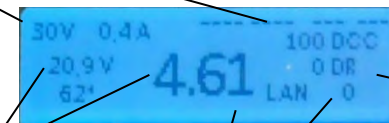

Leaving the "normal screen" is possible by the following events:

⇨ (Flash drive)

Insert flash drive (with the files to update the MX10 and/or the decoder software or to load sound into the root directory) → screen **TURQUOISE** : Flash drive options (Chapter 8 / 8.8 & 8.9)

⊂⊂ (Rotating fast) → Screen **YELLOW**: VOLT & AMPERE Configuration (8.2).

⊥ Press rotary knob LONG (2 sec) → screen **RED**: Broadcast Stop (BCS) and power OFF (8.3).

Press **Button 3** (↵) → screen **GREEN**: "BaseCab", Driving and programming (8.4, ..., 8.7)

Press **button 2** (MENU) → screen **GREY**: MENU for operating the MX10 (chapter 8.8).

Press **Button 1** (↵) → screen **GREY**: AOS (automatic operation sequences)

**Overcurrent** on a track → screen **RED**: OVC on track 1 or 2 (other one runs as usual) (8.3)

**Undervoltage** From input (power supply unit) → screen **RED**: Power supply not enough.

Overview over applications: see chapter 8.8 - MENU



## 8.2 Voltage & Current Setting

Screen in normal operation **BLUE**  
 if the rotary knob is turned fast,  
 it changes to voltage & current setting screen.

This **⏪** **VOLT & AMPERE MAIN (main settings)** **YELLOW**

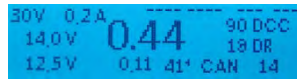

means:



Current threshold OVC  
 track 1 - upper value  
 track 2 - lower value

Running voltage  
 track 1 - upper value  
 track 2 - lower value

**NOTE:** The configurations in “main settings” correspond to the points “running voltage” and “OVC threshold” in the “detailed setting” (see description below). This display can also be reached via the MX10 menu (chapter 8.8).

### APPLICATION:

- ⏪ Scrolling with the rotary knob: set cursor (▶) to the value that shall be changed.
- ⏴ Press rotary knob → marked (▶) value is framed, you can now change the value.
- ⏪ Change the value with the rotary knob and adjust it according to your wishes.  
 in case of voltage: immediately effective on the track output.  
 in case of current limit: Shows threshold, measured value is shown again later.
- ⏴ Press rotary knob → adjusted value is stored, the rotary knob now scrolls again.

### RETURNING to normal operation or to menu:

Press **BUTTON3** (⏴) → to normal screen **BLUE**

or

⏪ Position cursor (▶) on “EXIT” and press rotary knob  
**Timeout** after 3 seconds without operation → normal screen

or

Press **button 2 (MENU)** → to the menu screen **GREY**

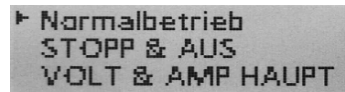
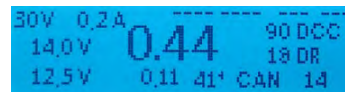

### Proceed (from the main settings) to the detailed settings:

Press **BUTTON 1** (▶) → to voltage & current detail screen **YELLOW**

### VOLT & AMPERE DETAIL (detailed setting)

This **YELLOW** configuration screen can also be accessed via the menu-line **VOLT & AMPERE DETAIL** (see 8.8)

The “detailed setting” provides a number of parameters surpassing the “main settings” for a perfect adjustment of the individual needs.

Each of the values is displayed and has to be adjusted individually for track 1 and 2. Those lines are marked by **1:** and **2:**

Additionally: for addressing and programming procedures in service mode on track 2 (i.e. track 2 as programming track) there are the lines **SERV:** and for updates and sound loading processes the lines **UPD:**

**NOTE:** During addressing and programming procedures in service mode on track 2, the values adjusted in “2” change to the values defined in “SERV”; the same is valid for updating procedures. This can either mean a rise or a lowering of the track voltage.

In many cases the default values can be used, especially if the potential capacity of the device is not fully used.

### APPLICATION:

- ⏪ Scrolling with the rotary knob: Set cursor (▶) to the parameter  
 On the screen only two or three lines are visible at the same time.
- ⏴ Press rotary knob → marked (▶) value is framed, you can now change the value.
- ⏪ Adjust the tagged value with the rotary knob according to your wishes.  
 Press **Button 3** (⏴) (instead of rotary knob) → undo erroneous adjustment.
- ⏴ Press rotary knob → adjusted value is stored.

### RETURN to normal operation:

Press **BUTTON3** (⏴) → to normal screen **BLUE**

1: Fahrspannung	14.2V
1: Hochfahrstrom	5.0A
1: Hochfahrzeit	0.0S
1: UES Schwelle	5.0A
1: UES Abschaltzeit	0.2S
1: UES Adaptiv	0.0A
1: UES Adaptivzeit	0m
1: UES Tol. Strom	0.0A
1: UES Toleranzzeit	0.0S
1: Funkenlöschung	AUS

2: Fahrspannung	12.2V
2: Hochfahrstrom	3.0A
2: Hochfahrzeit	0.0S
2: UES Schwelle	3.0A
2: UES Abschaltzeit	0.2S
2: UES Adaptiv	0.0A
2: UES Adaptivzeit	0S
2: UES Tol. Strom	0.0A
2: UES Toleranzzeit	0.0S
2: Funkenlöschung	AUS

SERV: Fahrspannung 14.0V  
 SERV: UES Schwelle 1.0A  
 SERV: Abschalt Zeit 0.2S

Upd: Fahrspannung  
 Upd: UES Schwelle

12V Strom	0.01A
32V Strom	0.10A

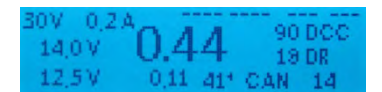

**Meaning of the parameters in "VOLT & AMPERE detailed setting",**  
for 1: (Track 1) and 2: (Track 2) in normal operation:

<b>Running voltage</b>	Range	10 V - 24 V	Default	16 V
------------------------	-------	-------------	---------	------

Target voltage on the output track 1 bzw. track-2. This voltage is kept within a range of 1V; if this is not possible, turn off "UND" (undervoltage, usually because of a too weak power supply unit).

<b>Start-up voltage</b>	Range	0.5 A - 16 A	Default	the same as OVC threshold
-------------------------	-------	--------------	---------	---------------------------

During the start-up of a track output (starting up the system or restart after a short circuit) the start-up voltage allows a higher current flow during the "start-up time" (see below) than allowed by the "OVC threshold", to charge the capacitors in the vehicles on the layout. The needed in-rush current for standard vehicles usually lies between 100 - 300 mA, for non-standardised vehicles it can be even higher.

<b>Start-up time</b>	Range	0 sec - 60 sec	Default	0 sec
----------------------	-------	----------------	---------	-------

When starting up the track output, the "start-up voltage" is taken into consideration instead of the "OVC threshold" to identify overcurrent. This limit can force a reduction of the output voltage (which rises slower); therefore the turn-off due to undervoltage is deactivated.

<b>OVC threshold</b>	Range	1 A - 12 A	Default	5 A (S-1), 3 A (S-2)
----------------------	-------	------------	---------	----------------------

OVC = overcurrent. The current on the track output shall be limited to the "OVC threshold" defined here, the output shall be turned off after the "OVC turn-off time" (see below). Only exception: within the "resilience time" for the selected "resilience" (see parameters below) the current may be higher.

<b>OVC turn-off time</b>	Range	0.1 sec - 5 sec	Default	0.2 sec
--------------------------	-------	-----------------	---------	---------

When reaching the current threshold (currently active according to "adaptive OVC" or the absolute limit according to "OVC threshold"), the track output is limited to the threshold - which is then used as constant current - what leads to a forced reduction of the running voltage. The output is turned off if the overcurrent is still present after the "OVC turn-off time" has run out. The turn-off time allows passing wrongly polarised frogs, by ignoring the short-time short circuits.

<b>Adaptive OVC</b>	Range	0.1 A - 6 A	Default	2 A
---------------------	-------	-------------	---------	-----

While the "OVC threshold" (see above) defines the maximum of current on each output, the "adaptive OVC" defines how high the sudden rises in power consumption may be. After high jumps the system shall be turned off, independent of the absolute limit.

<b>OVC adaption time</b>	Range	1 sec - 10 sec (at least 5-fold turn-off time)	Default	2 sec
--------------------------	-------	------------------------------------------------	---------	-------

The height of the "Adaptive OVC's" current jump is the difference between the elevated current and the average current in the time before. The value is calculated in "Adaptive OVC". This configuration shall not be changed.

<b>OVC permitted current</b>	Range	0 A - 6 A	Default	0 A
------------------------------	-------	-----------	---------	-----

The "OVC threshold" (i.e. the normally permitted track current, see above) may be surpassed for the defined "OVC permitted time" (below) by the defined "OVC permitted current". After this, the system is shut down, applying the turn-off time (see above).

<b>OVC permitted time</b>	Range	0 sec - 60 sec	Default	0 sec
---------------------------	-------	----------------	---------	-------

Period of time in which higher track current than defined in the OVC threshold is allowed. See description above (OVC permitted current).

<b>Spark suppression</b>	Range	OFF - LEV1 - LEV2	Default	LEV 2
--------------------------	-------	-------------------	---------	-------

Special circuits in the power amplifiers of the track outputs make sure that despite the high output power in case of a short circuit, there are no sparks, also when passing a frog or at derailments.

**Starting from the controller**

No: the MX10 starts operation on track 1 with the last used (driving) configurations.

Yes: the MX10 starts operation on track 1 after the stopping state is confirmed on the controller MX32. The programming track is not affected.

**Meaning of the parameters in "VOLT & AMPERE detailed settings",**  
for **SERV** (track 2 as programming track) and **UPD** (track 2 for decoder updates and sound loading)

<b>SERV: Running voltage</b>	Range	10 V - 24 V	Default	12 V
------------------------------	-------	-------------	---------	------

Target voltage on track output 2 during programming procedure in service mode (SERV PROG); otherwise, the configuration for track 2 ("2.") are valid.

<b>SERV: OVC threshold</b>	Range	400 mA, 1 A - 8 A	Default	400 mA
----------------------------	-------	-------------------	---------	--------

OVC = overcurrent. The current on the track output (track 2 in service mode) shall be limited to the "OVC threshold".

The configuration "400mA" largely corresponds to the standard defined by "RailCommunity" (VHDM) RCN-216: The current consumption is limited to a relatively low value and furthermore controlled after 150 msec, if the current dropped to 100 mA. The programming procedure continues only under these circumstances, otherwise the tracks are turned of. This is a traditional safety precaution on programming tracks and shall prevent overheating and damage on possibly wrongfully connected decoders.

Configurations 1 A, etc. do not have special time-dependent limitations; only while waiting for the acknowledgement it switches to current limitation (300 mA) to attenuate the acknowledgement impulse (so the loco doesn't "jump").

<b>SERV: OVC turn-off time</b>	Range	0.1 sec - 5 sec	Default	0.1 sec
--------------------------------	-------	-----------------	---------	---------

Operating principle see description of track 1 and track 2. Due to the fact that usually no frogs are passed when the track is used as programming track, this value is set very low.

<b>UPD: Running voltage</b>	Range	10 V - 24 V	Default	12 V
-----------------------------	-------	-------------	---------	------

Target voltage on output track 2 during updating or sound loading procedure; otherwise the configurations for track 2 are valid.

<b>UPD: OVC threshold</b>	Range	1 A - 8 A	Default	3 A
---------------------------	-------	-----------	---------	-----

OVC = overcurrent. The current on the track output shall be limited to the here defines "OVC threshold".

<b>UPD: OVC turn-off time</b>	Range	0.1 sec - 5 sec	Default	0.1 sec
-------------------------------	-------	-----------------	---------	---------

Operating principle see description of track 1 and track 2. Due to the fact that usually no frogs are passed when the track is used as programming track, this value is set very low.

**NOTE:** concerning acknowledgement detection in SERV PROG:

The MX10 automatically controls, if the **standby current** of the vehicle on the programming track after a programming or reading command

- within a certain time span (1 sec)
- falls beneath a certain value (100 mA beneath the set "SERV: OVC threshold", i.e. 300 mA, if OVC threshold is set to 400 mA by default),
- does not show strong fluctuations (less than 10 % of the standby current, if the standby current is higher than 10 mA).

If this condition for the standby current is not fulfilled, the MX32 shows the following warning: „Max. Current xxx A; WARNING: SERV - max. current not defined corresponding to standard“.

### 8.3 Broadcast Stop (BCS, BCSe), turn off voltage (OFF), Overcurrent (OVC), Undervoltage (UND) – STOPP & OFF

Starting point: Normal screen **BLUE**

Press rotary knob LONG (4 sec) or double-press within 1 sec

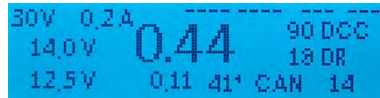

→ Screen colour changes to **RED**, STOPP&OFF - screen: **Broadcast Stop (BCS) on track 1**, normal operation on track 2 stays active.



State of track 1: *BCS - Broadcast Stop*  
 Preview on state after pressing T1 - OFF  
 State of track 2 (below): *Normal operation stays active.*  
 Changing state with T2 - BCS

**NOTE:**  
 ↓ Press rotary knob VERY LONG (8 sec) → **SYS OFF = STANDBY**

In "STANDBY" all outputs are turned off, i.e. track and DC outputs, as well as the supply wires on the bus cables. Therefore, also the controllers are turned off.

**ATTENTION:** In "STANDBY" the command station itself is still powered; the controller part continues to run. For safety reasons, "STANDBY" shall only be used under supervision.

The STOPP & OFF screen can also be reached via the menu point STOPP & OFF (chapter 8.8). If this screen is called up from the menu, both track outputs are in operating state ON. To stop track 1, **button 1 (T1)** has to be pressed, and for track 2, **button 2 (MENU)**.

Broadcast Stop (BCS), voltage off (OFF), can also be controlled and cancelled via controllers, and are shown on their displays and on the MX10's display.

Button 1 → track-1  
 or  
 Button 2 → track 2

The states of track 1 and track 2 (independently with individual keys each) can be switched cyclically:

**BCS (Broadcast Stop) → OFF (voltage off) → ON (normal operation) → BCS → OFF → etc.**

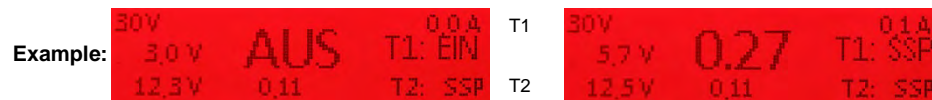

As soon as both track sections are turned on again → (after 2 sec) it switches automatically to normal operation, normal screen **BLUE**

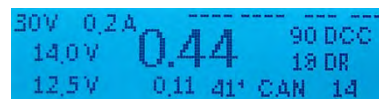

Press **BUTTON3** (↵) → to "not so normal" \*) normal screen **RED**

\*) "not so normal" means that BCS and OFF operations are **NOT** cancelled and therefore, the usually blue screen is **RED**; the trains on track 1 do **NOT** start.

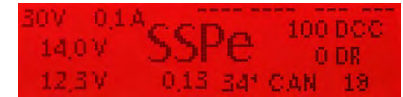

This "not so normal screen" is used to reach AOS, MENU and LOCO with the buttons 1, 2, 3 (as in the "real" normal screen). This way, complete operation is possible, also if one of the track outputs is turned off or stopped.

To get back to the "STOPP & OFF" screen from the "not so normal screen":  
 (to switch the states of track 1 and track 2 with buttons 1 and 2)

Press **button 2 (MENU)** → shows MX10 MENU **RED**  
 (Cursor on STOPP & OFF)



and again:

Press **button 2 (MENU)** → normal screen **BLUE**

or

↓ Press rotary knob LONG (4 sec) → STOPP & OFF screen **RED**

Now, the states of track 1 and 2 can be switched cyclically independently.



If you change from the "not so normal screen" via pressing the rotary knob long (4 sec) in the STOPP & OFF screen, consider the following:

State of track 1: **ON → BCS**

**BCSe / OFF → no change**

State of track 2: no change

Means: if track 1 is ON, it is set to (Broadcast Stop) BCSe when entering into the stopping operation.

Canceling broadcast stop started by the rotary knob: going back to normal screen:

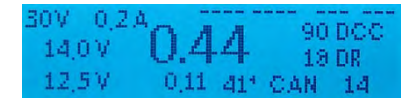

↓ Press rotary knob → track 1 BCSe = **ON** and back to normal screen **BLUE**

**ATTENTION:** This is only valid if the rotary knob was pressed LONG in the normal screen to start broadcast stop (track 1 = BCSe and track 2 = ON) or if this state is called up (again) manually in the STOPP & OFF screen (by repeatedly pressing button T1 and T2).



**Overcurrent (short circuit) on track 1 or track 2 or undervoltage on track 1 or track 2** → screen colour changes to **RED**, STOPP & OFF screen.

Starting point in this example: Normal screen **BLUE**  
Overcurrent and undervoltage messages are shown on every screen of the MX10 (e.g. LOCO, SERV PROG,...)

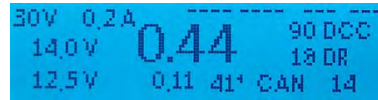

**OVC = overcurrent**

= current reached OVC threshold;  
Turn-off because of overcurrent of the track on which overcurrent (short circuit) was detected.



**UND = undervoltage**

= power supply unit cannot provide the necessary primary voltage to enable the necessary running voltage. The primary voltage has to be at least 3 V higher than the configured running voltage!



Those screens are the same as after starting broadcast stop (“**BCS**” or “**OFF**”) (except the text “**OVC**” or “**UND**”) from the MX10 or the controller. Therefore, also the procedure to re-start, etc. is the same:

Button 1 → track-1  
or  
Button 2 → track 2

The states of track 1 and track 2 (independently with individual keys each) can be switched cyclically:

**OVC** (overcurrent) → **ON** (normal operation) → **BCS** (broadcast stop) → **OFF** (turned off) → **ON** ...

e.g. turning on again with **button 1** (↑):

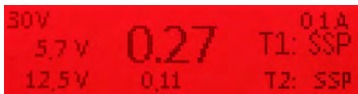

→ switches automatically (after 1 sec) to normal screen **BLUE**.

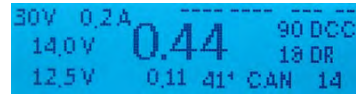

... in case both track outputs are turned on again, the normal operation is reinstalled.

If it is not possible to start the normal operation via turning on both track outputs, the error which caused the OVC or UND is still not solved (principle of a FI). It is turned off again after the defined turn-off time (VOLT & AMPERE detailed settings).

**NOTE:** OVP = Overcurrent on the programming track

*Described in the following: Reaction of the device and handling defects.*

The notifications “**WOC**” and “**VTG**” described in the following, only occur in case the MX10 has a hardware defect concerning the power supply circuits or if a power supply unit acts unexpectedly.

*We recommend contacting **ZIMO service** ([service@zimo.at](mailto:service@zimo.at)) and/or send it to **repair**.*

**Wrongly detected overcurrent on track 1 / track 2** → screen colour changes to **RED**, STOPP & OFF screen

**WOC = “Wrongfully detected” overcurrent**  
= current reached “wrong” OVC threshold



This notification (“**WOC**”) means that the track output was turned off because of “overcurrent” (actually “**OVC**”) although the value defined in “VOLT & AMPERE” was not reached, and also the power supply unit does not provide too little voltage (this would be “**UND**”). If this error occurs, the reason probably is a defect in the current limiting circuit.

**Voltage error on track 1 / track 2** → screen colour changes to **RED**, STOPP & OFF screen

**VTG = Wrong (usually too high) voltage on the track**  
= the controlling voltage measurement on the output detected a higher value.



This notification (“**VTG**”) means that the track output discharged a wrong voltage, usually higher than defined in “VOLT & AMPERE”, and was therefore turned off automatically. This can lead back to a defect or to an external voltage. The defect is potentially dangerous for the rolling stock, especially if it has relatively low running voltages defined (and therefore the difference to the occurring overcurrent may be relatively high).

These screens (“**WOC**”, “**VTG**”) and otherwise (except for the texts) are exactly the same as with “**BCS**”, “**OFF**”, “**OVC**”, “**UND**”. Therefore, also the procedure to re-start, etc. is the same: Therefore, also the procedure to re-start, etc. is the same:

Button 1 → track 1  
or  
Button 2 → track 2

→ The states of track 1 or 2 (independently with individual keys each) can be switched cyclically:

**WOC** (overcurrent) → **ON** (normal operation) → **BCS** (broadcast stop) → **OFF** (turned off) → **ON** → **BCS** → **OFF** → etc.

### 8.4 BaseCab LOCO (driving op. via central command station)

*THIS FUNCTION IS NOT YET IMPLEMENTED - THIS IS A DESCRIPTION OF THE PROJECT*

Starting point is the normal screen **BLUE**

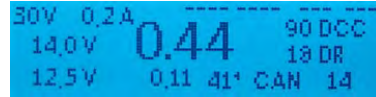

Press **Button 3** (▷) → screen colour changes to **GREEN**, "BaseCab" LOCO - screen

*This screen can also be reached via the menu line "BaseCab LOCO" (see chapter 8.8) and also from the "ObjectDB vehicles" by pressing the rotary knob on the desired line, in this case already with the vehicle address.*

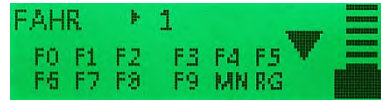

◁ Scrolling with the rotary knob: set cursor (▶) to the value that shall be changed.

If the loco address is marked by the cursor (▶):

- ⌄ Press rotary knob → loco address is framed and ready for change,
- ◁ Define desired loco address via rotary knob ("accelerated rotary effect"),
- ⌄ Press rotary knob → Defined loco address is fixed (rotary knob is freely usable).

If the driving bar is marked by the cursor (▶):

- ⌄ Press rotary knob → displayed "slider" with current speed step is framed,
- ◁ Regulate speed with rotary knob (in this case DCC internal speed step (0 ... 126)
- ⌄ Press rotary knob → change direction of travel,
- ⌄ Press rotary knob LONG → current speed step is fixed (rotary knob is freely usable).  
(CAUTION: "LONG" means about 2 seconds, "VERY LONG" (= about 4 sec) activates BCS - broadcast stop).

If the function group (0,1,2 / 3,4,5 / ...) is marked by the cursor (▶):

- Whole function field scrolls if needed, if F19, F1, ... shall be accessed.
- (Without further pressing) the corresponding functions are switched with buttons 1, 2, 3.
- ⌄ Press rotary knob → the corresponding functions are "fixed" i.e. the rotary knob gets speed slider, the three buttons stay assigned, the fixation is shown by the change of the cursor from ▶ to ■.
- (⌄ Press rotary knob LONG → current speed step is fixed, rotary knob is freely usable),
- ◁ Mark another function group with the rotary knob → first "fixation" is cancelled.  
Also "passing by" and stopping the cursor, for example on address or driving bar is enough.

**NOTES:** The address that was called up uses or produces a normal memory block (as do trains controlled by controllers) with the priority steps change / foreground / not in the controller anymore.

If a loco address is already available in the ObjectDB, the current driving data is taken and shown from there.

If the "BaseCab" screen is called up again, first the last address controlled with "BaseCab" appears; power-on of the device in this case is irrelevant.

Fahrzeugadresse markieren (Drehen, Drücken)

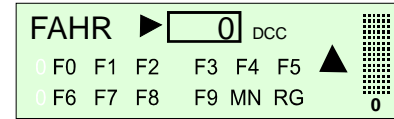

Fahrzeugadresse einstellen (Drehen)

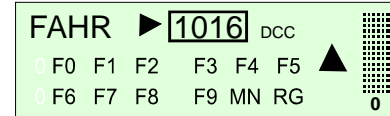

Fahrzeugadresse fixieren (Drücken),  
Fahrbaalken markieren (Drehen, Drücken)

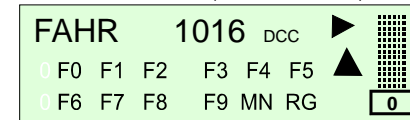

Fahrstufen + Richtung steuern (Drehen, Drücken)

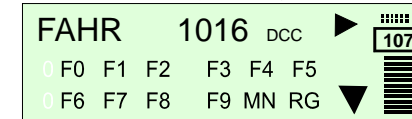

Eine Funktionsgruppe markieren und schalten

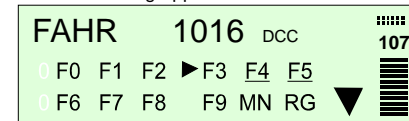

Funktionsgruppe fixieren, Fahrstufen steuern

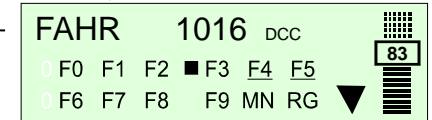

Andere Funktionsgruppe markieren

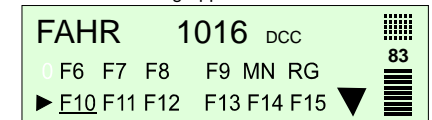

**LEAVING "BaseCab":**

- Press **button1** (1) LONG → to program CVs, the "BaseCab OP PROG" screen.
- Press **button 2** (MENU) LONG → to get to the menu (limited to VOLT & AMP, BaseCab, DCC, ...)
- Press **button 3** (▷) LONG → resume to normal display (if this was your starting point) or to MENU (if this was your starting point) or to ObjectDB (if this was your starting point)

**NOTE:** If no function group is marked, pressing SHORTLY is sufficient!

### 8.5 BaseCab OP PROG (Programming CVs via the central station)

THIS FUNCTION IS NOT YET IMPLEMENTED - THIS IS A DESCRIPTION OF THE PROJECT

Starting point is the "BaseCab LOCO" screen **GREEN** (see chapter 8.4)

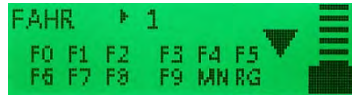

Press **button 1** (1) LONG → screen stays **GREEN** - "BaseCab OP PROG" screen

This screen can also be reached via the menu BaseCab OP PROG (see chapter 8.8).

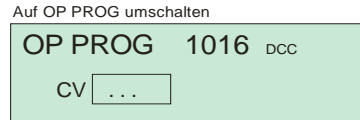

⌚ adjust the tagged value (=CV number) with the rotary knob according to your wishes.

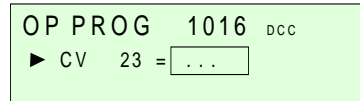

⌚ Press rotary knob → fix adjusted CV number; go to next field (e.g. CV value)

⌚ adjust the tagged value (=CV value) with the rotary knob according to your wishes.  
 ⌚ Press rotary knob → program adjusted value into decoder; open next line

If programming was successful (acknowledged by RailCom feedback) the MX10 displays: „ACK RC“

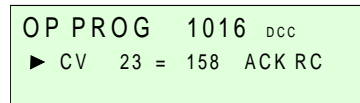

If there is no feedback from the decoder, the display shows "SENT" instead of "ACK"

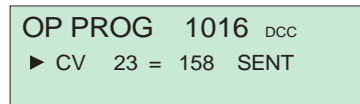

⌚ Press rotary knob again → open next line

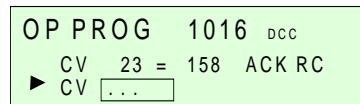

**Read CVs:**

As above (program CVs), but:

Do not enter CV value, but immediately ⌚ press rotary knob, feedback "READ"

**NOTE:** Scrolling back to finished programming and reading lines is NOT possible.

**LEAVING "BaseCab:** press **button 3** (3) LONG → back to LOCO or MENU

### 8.6 BaseCab SERV ADR (addressing decoders)

THIS FUNCTION IS NOT YET IMPLEMENTED - THIS IS A DESCRIPTION OF THE PROJECT

Via the MENÜ (see chapter 8.8) (the menu can also be reached from "BaseCab LOCO", by pressing **button 2** (MENU) LONG)

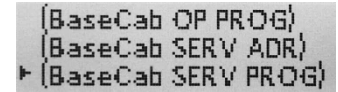

⌚ Set "BaseCab SERV ADR" in the menu and  
 ⌚ Press rotary knob → screen colour changes to **YELLOW**, "BaseCab SERV ADR" screen

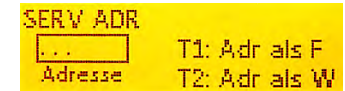

⌚ adjust the tagged value (=address) with the rotary knob according to your wishes.  
 ⌚ Press rotary knob → program adjusted address into decoder

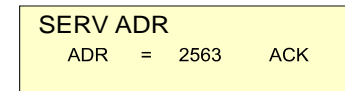

**Read out address:**

As described above, but: do not enter CV value, but immediately ⌚ Press rotary knob, feedback "READ"

### 8.7 BaseCab SERV PROG (programming CVs)

THIS FUNCTION IS NOT YET IMPLEMENTED - THIS IS A DESCRIPTION OF THE PROJECT

Via the MENÜ (see chapter 8.8) (the menu can also be reached from "BaseCab LOCO", by pressing **button 2** (MENU) LONG)

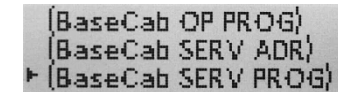

⌚ Set "BaseCab SERV PROG" in the MENU and  
 press rotary knob → screen colour changes to **YELLOW**, "BaseCab SERV PROG" screen

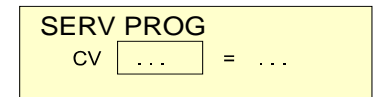

⌚ adjust the tagged value (=CV number or value) with the rotary knob according to your wishes.  
 ⌚ Press rotary knob → fix adjusted value, program into the decoder

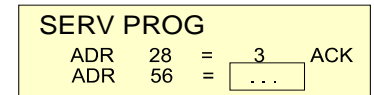

**Read CVs:**

As above (for programming CVs), but:

do not enter CV value, but immediately ⌚ press rotary knob, feedback "READ"

**NOTE:** Scrolling back to finished programming and reading lines is NOT possible.

**LEAVING "BaseCab:** press **button 3** (3) → back to MENU



### 8.8 The MX10 MENU (main menu)

Starting point is the normal screen **BLUE**  
or VOLT & AMPERE **YELLOW**

Press **button 2 (MENU)** → shows MX10 MENU **GREY**

**NOTE:** Some of the menu points are **not yet** working with the current software version.

For further information regarding this topic please visit our homepage: [www.zimo.at](http://www.zimo.at) "Update & Sound" -> "Update - System (MX10, MX32, ...)" or consult this instruction manual. The menu points in parentheses are either not yet implemented or are not completely functional.

- ↻ Scroll with rotary knob: set cursor (▶) to desired application or screen (on the screen only three lines are visible)
- ⌄ Press rotary knob → Marked line is called up, the corresponding screen and colour change is called up.

Press **button 3 (↵)** → back to normal screen **BLUE** (button 3 directly from the menu) button 3 from the application leads back to the menu.

**GRAY lists:**  
Show the corresponding list in "reading mode", the rotary knob scrolls.

**YELLOW lists:**  
After selecting a menu point from the list by pressing the rotary knob, it turns yellow, now an input and selection field is open and the value can be changed.

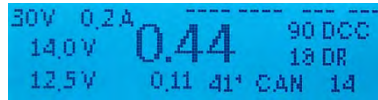

**MENU point STOPP & OFF - screen → RED**



After entering in the STOPP & OFF screen via the menu, broadcast stop is not activated automatically. To activate broadcast stop (BCS) on the outputs Schiene-1 (track 1) and/or Schiene-2 (track 2), or to turn off the running voltage (OFF), use buttons T1 for track 1 and T2 for track 2. With buttons T1 and T2 all possible states of the tracks are set one after the other: ON – BSC – OFF – ON – BCS – OFF – ON ... etc.

**NOTE:** The same "BCS & OFF" screen is reached as well via the menu point of the MX10 as via the commands broadcast stop or track-off by a MX32, or "STOPP" via long pressing the rotary knob on the MX10. In both cases, the stopping screen is called up and already shows STOPP or OFF. Buttons T1 and T2 are used to restart. (State order as described above.)

See chapter 8.3

**Menu point VOLT & AMPERE MAIN → YELLOW**

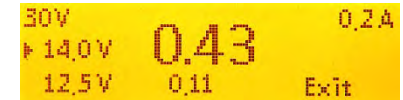

Configuration of running voltages and maximum current (on tracks 1 and 2); whereby the corresponding track output reacts immediately to changes of the running voltage.

See chapter 8.2

**Menu point VOLT & AMPERE DETAIL → YELLOW**

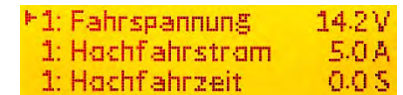

Configuration of running voltages, maximum current, turn-off times, temporarily allowing higher currents, etc. on track 1 (1:) and track 2 (2:), and also for track 2 as programming track (**SERV:**) and as updating and sound loading track (**UPD:**).

Starting from the controller:

See chapter 8.2

Menu point **MX10 Config** → **GREY**

⤵ Scroll with the rotary knob to the desired menu point, the cursor (▶) marks the current position.

⬇ Press rotary knob →, the value is marked, or or the selected submenu is opened.

⤵ the value or option is adjusted with the rotary knob.

⬇ Press rotary knob again → fix and save. The rotary knob now again is used to scroll.

**Button 3** (↶) → back to the MX10 menu

▶ Sprache:	Deutsch
Funk Kanal:	20
Anlauf Speed:	Restore
Anlauf MAN:	Restore
Anlauf Fu:	Restore
Anlauf Züge:	Restore
Anlauf Zub:	Aus
DrehK. lang:	SSP 1+2
Boo UE Leit:	SSP 1+2
Sync Mode:	Getrennt
Mastr/Boostr:	Master
Sniffer Inp.:	
Adr Analog:	0
Adr MX10 Sound:	16311
Adr MX10 BAB:	16312
Date/Time	
Versions Info	
Info/Statistik	

- If the **language** is changed here, it switches immediately. All texts that are not available in the selected language are replaced by the German texts.

- The **radio channel** can be looked up in MX32 PULT CONF. This radio channel can be adjusted in the MX10 to prevent radio collisions with other devices.

- "**Start-up**" defines, if after starting-up the system all trains (decoders) and/or turnouts (accessory decoders) are set to the state they were before the system was turned off. Configurations can be: a) a complete "restore" (this is the default configuration), b) automatically turning on the functions, c) automatic run-up to the previously set speeds, d) only the last state of the accessory decoders or e) all decoder data is deleted. Also, the activation/deactivation of the MAN bit is configured here.

- **Booster Error**: Configuration of the operating state after an overcurrent notification of the connected booster or by activating the emergency stop button via the "Boo UE" input of the booster socket (MX10 back ZIMO CAN). Options: "BCS S1", "BCS S2", "BCS S1+S2", "OFF S1", "OFF S2", "OFF S1+ S2" or "Message".

- **Rotary knob long**: Function of the rotary knob when pressed for 4 seconds. Options: Ignore, System Standby (Default) or track OFF.

- "**Sync**" defines, if track 1 and track 2 work independently (default, different running voltages, BCS possible, etc.) or completely identical regarding state, voltage and command, so a parallel use (for one circuit of up to 20A) is possible.

- Select, if the device shall be **Master** or **Booster**.

- **Sniffer Input**: prepared.

- "**Analog address**" i.e. virtual address (can be called up from the controllers) for analog vehicles, which are controlled corresponding to NMRA with the "stretched 0-Bit method".

- "**MX10 Sound**", virtual address for the sound generator (including built-in speaker and audio socket), via which it can be called-up at the controller to play back some of the stored sound samples via function keys.

- Virtual **address for MX10 OSE** Calls up operation sequences after the address was activated on the controller.

- **Date/Time**: In this submenu of "MX10 Config", time and date can be changed, as well as the model railway factor can be adjusted → with the rotary knob as described on the left. The data changed on the MX10 is also stored in the MX32 as soon as the system is restarted.

- **Version Info**: This screen contains information about the software currently on the device and its creation date. Here you also find the current software of the radio processor.

**NOTE**: The radio processor software of the MX10 should match the one in the MX32 ("Pult Conf" - "HW/SW Version Info") Otherwise, the radio connection will be bad or not work at all.

- **Info/Statistics**: This data is only for information purposes and cannot be changed in this screen.

"Live Time" is the absolute on-time of the MX10, while "Run Time" shows the time since the last start-up of the system.

The vehicles and accessory decoders stored in the MX10 are shown in DCCb, DCCx and MM1 format.

DCC all: total of all sent DCC packets within the "Run Time". It is divided into DCC speed (speed commands), DCC Fx (function commands) and DCC Acc (accessory commands).

The ZACK-registration can be turned ON or OFF in "DCC signal setting" and is set to the state SCAN if an address of a new vehicle on the tracks is determined. After scanning, the ZACK address is shown. ZACK step shows how many calculation processes had to be done to determine the address.

"Peak temp" shows the highest measured temperature in Celsius at the voltage and current values shown beneath.

"Peak power" shows the highest voltage and current on each track.

Datum:	▶10 03 2017
Uhrzeit:	12 06 41
Faktor:	

▶ Version-HW:	00.05.1018
Version-SW:	01.20.0155
Comp. Date:	2017.03.03
Comp. Time:	12:24:47

Funk HW:	01.07.0005
Funk SW:	02.02.0009

▶ Live Time:	
Run Time:	2418

Fahrzeuge:	167
Zubehör DCCb:	33
Zubehör DCCx:	-1
Zubehör MM1:	

DCC ges:	137398
DCC Fx:	
DCC Acc:	

ZACK Mode:	0
ZACK Addr:	5120
ZACK Step:	0

Peak Temp:	51	Cels.
Schiene 1:	15.8/0.7	V/A
Schiene 2:	15.8/0.7	V/A

Peak Power:		
Peak Power:		
Schiene 1:	12.2/8.0	V/A
Schiene 2:	15.0/4.7	V/A

**Menu points BaseCab LOCO** → BaseCab LOCO - screen **GREEN**

This function is shown in parentheses on the MX10 and is therefore not fully implemented. You can call up the screen "BaseCab LOCO", but **not** use it.

See chapter 8.4

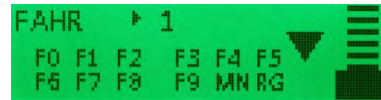

**Menu points BaseCab OP PROG** → BaseCab OP PROG- screen **GREEN**

This function is shown in parentheses on the MX10 and is therefore **not implemented**. You cannot call up the screen "BaseCab OP PROG". (Symbolic screen)

See chapter 8.5

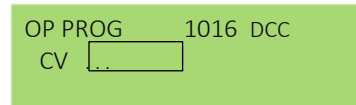

**Menu points BaseCab SERV ADR** → BaseCab SERV ADR- screen **YELLOW**

This function is shown in parentheses on the MX10 and is therefore not fully implemented. You can call up the screen "BaseCab SERV ADR", but **not** use it.

See chapter 8.6



**Menu points BaseCab SERV PROG** → BaseCab SERV PROG- screen **YELLOW**

This function is shown in parentheses on the MX10 and is therefore **not implemented**. You cannot call up the screen "BaseCab SERV PROG". (Symbolic screen)

See chapter 8.7

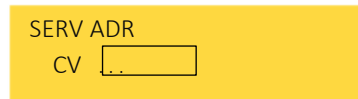

When using "BaseCab" on the MX10, you use the display and the operating elements (rotary knob, three buttons) as "controller": driving (i.e. controlling the speed and switch functions), addressing and programming CVs in service mode or in operational mode (POM) can be done with the MX10, i.e. without controller.

**Menu point ZIMO Decoder SW&Soud-Update** → listed from the file storage **TURQUOISE**

This function is **not realised** yet.

The screen you can call up looks currently like this (one decoder firmware file and one ReadyToUse-sound-file):

Decoder SW&Sound:  
▶ DS140623.ZSU  
US\_DA\_Coll.zpp  
back

After selecting an update or sound file, the Update and Sound loading screen → **YELLOW** is called up (after its completion: **GREEN**.)

Calling up the decoder SW updates from the menu means that a SW update collection file or sound project previously stored in the MX10's "file storage" shall be used; the available files are listed. In contrast to the situation in which the updating procedure is started by inserting a flash drive to use a file directly from this drive.

**See chapter 7** This chapter explains decoder software updates and sound loading from the file storage as well as from the flash drive.

**Menu points DCC signal configuration**

→ **Configuration screen GREY**

DCC Preamble: Adjustable number of Preamble bits; MX10 default is 26, this number must not be undercut in any case if an MX9 is used. NMRA standard defines 14 bits, ZIMO decoders also work with 10 preamble bits, whereby, in this case, the smallest loss of data leads to problems. Reducing the number of preamble bits allows a faster data transmission, but is only recommended for experienced users.

▶DCC: Preamble	26 Bits
DCC: Bit '0' Zeit	104 µS
DCC: Bit '1' Zeit	58 µS
DCC: Bit '1' Zeit	58 µS
RailCom	Auto
ZIMO ACK	AUS

DCC Bit ,0' / ,1' time: This is where the times for DCC bits 0 and 1 are defined. This function is only recommended for experienced users and is usually not necessary, because the default corresponds to the standard.

DCC RailCom: Auto: RailCom is turned off automatically, if a MX9 is detected, otherwise RailCom is always turned on. This is the default configuration of the MX10.

ON: Keeps RailCom turned on, no matter what devices are connected to the CAN bus. If MX9 are used, this can lead to problems with driving decoders or other components, therefore select "OFF"!

OFF: RailCom is turned off. This configuration has to be set with terminal loop modules, especially if they have a power surge relay, because otherwise, those would switch at every RailCom cut out which would lead to damage.

ZIMO ACK: ZIMO ACKnowledgement is the MX10's automatic loco number identification. At delivery it is turned off. You can choose between "Ackn." and "Search". If you wish a notification in a program on you computer or an address of a new vehicle shall be detected on the tracks.



**Menu points DCC SERV PROG settings** → Configuration screen **YELLOW**

ACK current: Set to 60 mA corresponding to the NMRA standard. For ZIMO decoders a current of 20 mA is usually sufficient. A smaller ACK current is needed, if small sensitive motors are used, e.g. N-gauge vehicles or in applications with function outputs without motors (wagons). Use bigger values if strong motors are used, e.g. as in large-scale locos.

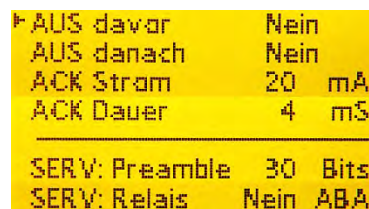

OFF before / OFF after: Usually set to "No". This function is only used in rare cases with third-party decoders, if those accept a reset command solely after a start-up. Therefore, the track is turned off for 500ms before every reading / programming command.

SERV: Number of preamble bits and selection if relay function shall be turned on via ABA inputs or not.

**Menu points MMx SIGNAL settings**

→ Configuration screen **GREY**

Timing and other parameters for MM (Motorola), whereby MM1 corresponds to accessories and MM2 to vehicles; "MMx" corresponds to both. Additionally it contains settings for mfx.

This function is shown in parentheses on the MX10 and is therefore not fully implemented. You can call up the screen "MMx SIGNAL settings", but **not** use it.

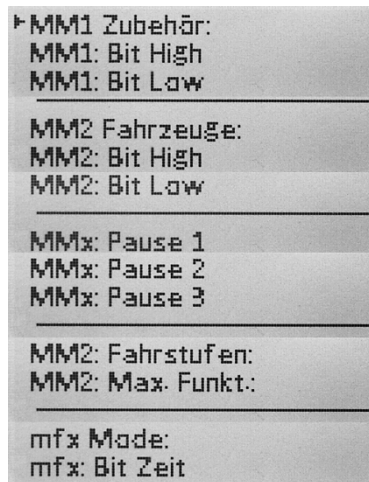

**Menu point AOS In/Out Monitor+Conf**

→ Monitor screen **GREY**

Reading the levels, configurations and response thresholds of the AOS inputs, allocations to trigger BCS and OFF, operating modes of the "AOS outputs".

If the levels on the AOS inputs fluctuates between 120 and 140, this input is "open", i.e. not occupied; if the level is  $\geq 0$  to ground and  $\leq 256$  to positive pole (level setting see below). If a value is read out that does not fit this range (e.g.180) although the input is open, this input is defective.

Inp. 6, Inp. 7 and Inp. 8 are set by default for the use of "Ackn." and can be changed in this menu.

See chapter 5. "Layout, programming track, AOS in/out"

○ Scroll with the rotary knob to the desired menu point, the cursor (▶) marks the current position.

↓ Press rotary knob → opens submenu

**Submenu Inp. 1-8:**

You can adjust the thresholds for up and down as well as their function: Ignore; Up/Dn; ON S1; BCS S1; OFF S1.

The "Up function" always refers to track 1, the "Dn function" to track 2. Both functions are equalized: if "Up function" is set to BCS S1, "Dn function" is automatically set to BCS S2.

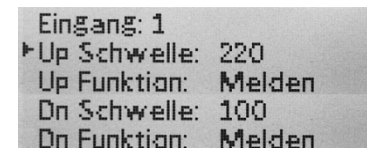

**Menu points Bus Config+Monitor**

→ Monitor screen **GREY**

CAN1 configures the bus protocol for the ZIMO CAN sockets (MX10: front and rear side, MX10EC: only rear side). Default: „ZIMO 2.xx (125)“

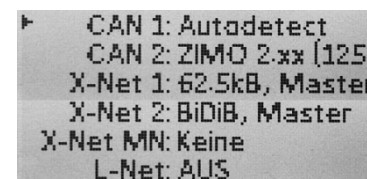

CAN2 configures the bus protocol of the second CAN bus on the XNET-socket (!) Default: „ZIMO 2.xx (125)“

XNET1 and XNET2 configure the bus protocols for the two possible XpressNet buses (both on the XNET socket). This concerns especially changing between variations of the XpressNet like Roco Multimaus and Massoth.

PICTURE WILL BE CHANGED

**Menu points PC Config+Monitor**

→ Monitor screen **GREY**

LAN IP address and Mask setting.

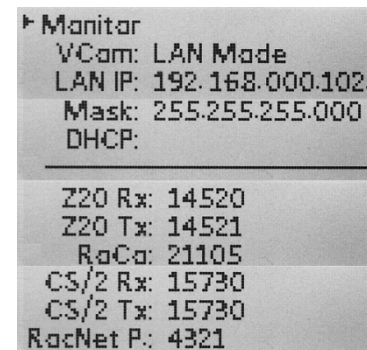

See chapter 10. „The interlocking program ESTWGI on the MX10“

Menu point **ObjectDB vehicles**

→ object list by addresses **GREEN**

```

850 85 007 0 ▲
860 BR 86 0 ▲
▶ 912 ----- 0 ▲
    
```

**NOTE:** Driving operation is also possible without looking at the Object Database. In the ZIMO system, almost any number of addresses can be managed at the same time; theoretically, the refresh cycle holds up to 8000 loco addresses (compared to other manufacturers, who are usually limited to 64 or 128). If this possibility is used (to some extent), it may be useful to investigate, why reaction times, for example, are getting longer, why refreshing packages are received infrequently, or which entries in the database could be deleted - and actually deleting them.

The centralised Object Database in the central command station usually contains automatically produced copies of all entries which are or were stored in the controllers (also if they were deleted from the controllers in the meantime). This centralised database is the basis for the sending organisation of data packets on the tracks as well as for transferring the GUI data between the input devices.

The menu point "ObjectDB vehicles" shows the contents of the centralised data base (registered loco addresses including their current driving data and data communication statistics) which can also be controlled there. Additionally, specific measures can be taken, especially deleting single addresses to relieve the sending cycle, or stopping the trains.

Calling up this menu point, the list of loco addresses with their (available) names, current speed step and driving direction are presented ("basic display").

⤵ Rotary knob → Scrolling through the list of addresses, "▶" as the cursor shows the current position.

**Button 1** (↵) → Changes the information shown for each address

Basic display 0: Address Name MAN bit speed step direction arrows \*)

**Button 1** (↵) → Displ 1: Address "in" traction name (or number) activation code \*\*)

**Button 1** (↵) Displ 2: Address device info: on which device this address is active (also LoR)

**Button 1** (↵) → Displ 3: Address P F M „Fu“ ■ ■ x x ■ \*\*\*)

**Button 1** (↵) → Displ 4: Address DCC packages / sec RailCom feedback / sec track format \*\*\*)

**Button 1** (↵) → Displ 5: Address feedback (via RailCom) speed (km/h) \*\*\*\*\*)

**Button 1** (↵) → Displ 6: Address manufacturer Decoder type (if ZIMO) ID \*\*\*\*\*)

**Button 1** (↵) → Displ 7: Debugscreen \*\*\*\*\*)

Press **button 1** (↵) LONG resume to basic display

**Button 2 (MENU)** → Sub menu, inter alia, deleting from the database (back from sub menu with button 3)

⤵ Press rotary knob → to "BaseCab" screen (if by mistake, resume with button 3)

\*) **Basic Display 0: Name & driving data**

Shows name (if available) and current driving data (i.e. MAN bit, speed, direction) for the loco address in question.

\*\*\*) **Display 1: Display traction info and activation code**

Those two do not have anything in common, they are combined for reasons of space. Traction info shows, where applicable, in which consist (name or number) or train the loco address is integrated.

```

850 85 007 50 ▲
860 BR 86 120 ▲
▶ 912 ----- 0 ▲

2110 Keine Traktion
▶ 2184 Keine Traktion
2804 Keine Traktion
    
```

Activation codes in display 1:

FG object (loco address) is in the **foreground** on the controller

HG object (loco address) is in the **LoR** of at least one controller

CS this object (loco address) received commands from the **computer** in the last 5 seconds

HG CS both ....

\*\*\*) **Display 3: DCC-packet monitor function**

Shows in intervals of about 0.5 seconds, what kind of packets were sent during this period for this address. The "flickering" frequency of a certain packet indicator (e.g. F or the third ■) represents the sending intensity of this data. If, for example, the slider on the controller is moved, the "F" indicator flickers every time, i.e. the DCC speed packet for this second was sent at least twice per second.

Especially interesting for diagnose and analysis are of course the addresses that are currently inactive or in the background of an input device, and therefore rarely integrated in the "refreshing" cycle. Potentially appropriate actions can be derived, like settings in "FUMZ" on the controller to avoid unnecessary packet transmissions.

Types of packets and their indicators:

**P** = programming commands (OP PROG); **F** = driving commands (speed steps and direction); **M** = MAN bit; „**Fu**“ ■ ■ ... = the 5 function packets:

F0 .. F4 | F5 .. F8 | F9 .. F12 | F13 .. F20 | F21 .. F28.

\*\*\*\*\*) **Display 4: DCC statistics & RailCom**

This is where the number of sent DCC packets and received RailCom feedback for the corresponding address is display:

In the cursor's line "▶": Number/sec

In the other lines on the screen: cumulated number of packets / feedback since the last power on.

**NOTE:** Those values only show, how many packets / feedback are counted to a certain address and do not distinguish between different types of packets (speed steps, function commands, etc.); the latter is shown in the previous screen (packet monitor).

\*\*\*\*\*) **Display 5: RailCom feedback**

This is where the content of the RailCom notifications is shown, especially the speed feedback (km/h), but also other information (compare: statistics of RailCom feedback in previous screen).

\*\*\*\*\*\*) **Display 6: Decoder information**

The most important information of the decoder of the corresponding loco address, i.e. manufacturer (according to "NMRA-ID" in CV #8), type (if ZIMO decoder or different registered manufacturer), ID (if available)

\*\*\*) **Display 2: device info**

```

2110 211 259 k-G (MX10)
▶ 2184 218 476 k-G (MX10)
2804 ----- k-G (MX10)
    
```

```

2110 Fu x ■ ■ ■ x
▶ 2184 F Fu x x ■ ■
2804 M Fu ■ ■ ■ x x
    
```

```

2110 17680 DCC 6252 RC
▶ 2184 1 DCC 1 RC
2804 7993 DCC 0 RC
    
```

```

2110 211 259-7 100 kmh
▶ 2184 218 476-0 0 kmh
2804 ----- 80 kmh
    
```

\*\*\*\*\*\*) **Display 7: Debugscreen**

```

2110 L= 0 S= D= 0
▶ 2184 L= 0 S= D= 0
2804 L= 0 S= D= 0
    
```

**Deleting vehicles from the database (ObjectDB vehicles):**

One of the most important functions of the menu point "ObjectDB vehicles" is the possibility to delete addresses manually (most of the time deleting whole address contingents) from the object database of the MX10, or of the whole system. Regarding the following steps within the menu point ""ObjectDB vehicles") this is rather comfortable:

- ↻ Scroll with the rotary knob to the first address to be deleted
- Button 2 (MENU)** to enter the sub menu
- ↻ Scroll with the rotary knob to the entry "delete"
- ↓ Press the rotary knob to actually delete the address
- Button 3 (↵)** resume to the address list (automatically positions the cursor beneath the last deleted address
- it is usually the case that the following address shall be deleted, too.
- Button 2 (MENU)** to enter the sub menu; this time automatically to the entry "delete"
- ↓ Press the rotary knob to actually delete the address
- Button 3 (↵)** resume to the address list
- etc. (same procedure: button 2 - rotary knob - button 3 - button 2 - rotary knob ...)

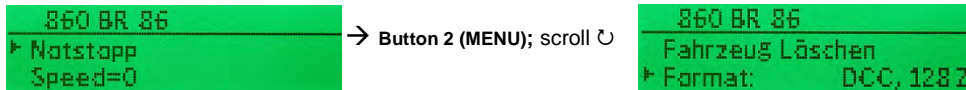

**Undelete:** Deleted addresses stay in the list, but are marked "DEL" or "deleted"; they can be reestablished via button 2 in the sub menu and there as "Undelete" (instead of "Delete") in the MX10's object database.



**ATTENTION:** Deleting an address from the MX10's object database (i.e. the systems centralized database) does **NOT delete** it from **local** databases in controllers (input devices). This means, if an address is reactivated from a local database (or only is called back into the recall memory), the corresponding address with all its data from the controller is loaded back into the MX10's centralised object database. In order to delete an address completely from the system, it has to be deleted from all devices (controller MX32 with E-6 to the ObjectDB, scroll to the address and delete it with the C-key).

**NOTE:** Additionally to "manually deleting addresses" as described here, there is also automatic deletion because a vehicle was not used for a long time or memory overload (the memory can store up to 1000 vehicles including GUI, etc.). The criteria thereof can be configured in the menu point "ObjectDB Auto-Clear" (depending on the current SW version of the MX10). Lists all active objects (loco addresses and names) with - eligible by button 1 - real time speed display including direction and MAN state, sending statistics (DCC packets ordered by type of command), etc. as desired. Detail screen for single addresses with possibility to delete it from the database, RailCom analysis, ...

- Object lines: address name MAN-bit speed step (1024 steps) direction arrows
- Button 1 (⏏)** Displ 1: Address "in" traction name (or number) activation code \*)
- Button 1 (⏏):** Address PRG F0 F5 F9 F13 F21 MN FS (Monitor function)
- Button 1 (⏏):** Address DCC packets / sec RailCom feedback / sec track format
- Button 1 (⏏)** Address feedback (via RailCom) speed (km/h) etc.
- Button1 (⏏)** Address manufacturer Decoder type (if ZIMO) ID
- Press **Button 1 (⏏)** LONG: resume to basic display
- Button 2 (MENU):** Detailed display, inter alia, with possibility to delete from database
- Press rotary knob → screen colour changes to **GREEN**, "BaseCab" - screen

\*) Activation codes:  
 FG object is in the foreground on one controller  
 HG object is in the LoR of at least one controller  
 CS this object (loco address) received commands from the computer in the last 5 seconds  
 HG CS both ....

**NOTE:** Depending on the software version, not all lines are available.

**Menu point ObjectDB consist**



**Menu point ObjectDB accessory**

Press rotary knob →

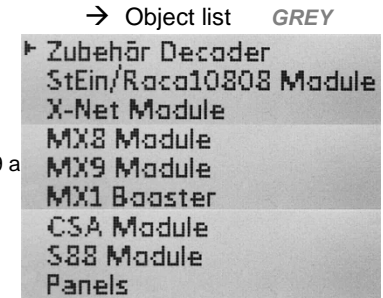

Currently you can only choose accessory decoder, MX8, MX9 a MX1 booster.

.. Accessory decoder screen

Black boxes by default (e.g. switches) correspond to the RED LED on the MX32, white boxes to the GREEN LED.

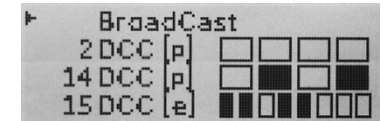

... MX8 screen

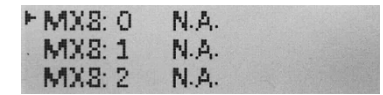

... MX9 screen

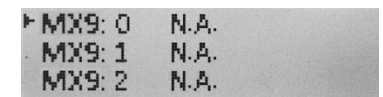

... MX1 booster screen

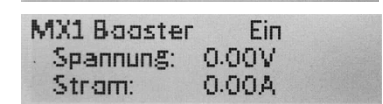



Menu point OS Monitor + Start

→ Object list GREY

Menu points ObjectDB Sounds  
 ObjectDB software decoder collection files  
 ObjectDB Sound projects

→ Object list GREY

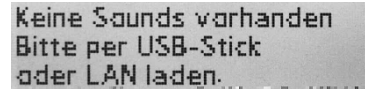

Keine Sounds vorhanden  
 Bitte per USB-Stick  
 oder LAN laden.

Lists of the sound samples stored in the MX10 (to play back via the “virtual address MX10 Sound”), software decoder collection file and sound projects for decoders (applicable via menu points “ZIMO decoder SW-Update” and “ZIMO decoder sound loading”)

Menu points Data Clear

→ Save & Restore & Clear GREY

Save and reload important data from and to the flash drive: ObjectDBs,  
 Settings of this menu, ...

Factory Reset | Delete texts | Delete Fonts | Delete Icons | Delete Sound |  
 Delete FahrzeugDB | Delete loco pictures | Delete decoder software |  
 Delete decoder sound projects

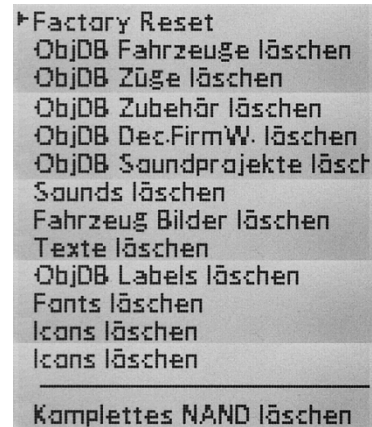

Factory Reset  
 ObjDB Fahrzeuge löschen  
 ObjDB Züge löschen  
 ObjDB Zubehör löschen  
 ObjDB Dec.FirmW. löschen  
 ObjDB Soundprojekte löscht  
 Sounds löschen  
 Fahrzeug Bilder löschen  
 Texte löschen  
 ObjDB Labels löschen  
 Fonts löschen  
 Icons löschen  
 Icons löschen  
 Komplettes NAND löschen

Menu points Debug Functions

→ Object list GREY

### 8.9 Insert flash drive with files to update decoder software or load sounds

To copy into the "file storage" or to carry out directly

THIS FUNCTION IS NOT YET IMPLEMENTED - THIS IS A DESCRIPTION OF THE PROJECT

Starting point normal screen **BLUE**

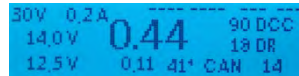

⇒ Insert flash drive (possible from every operation state; with files in the root directory for decoder software update, and/or to load sound)

→ Display colour changes to **TURQUOISE**, list of files stored on the flash drive is shown (first if necessary an update for the MX10, then the files for the decoder).

Sammelfilexyz.zsu  
▶ Sammelfile1234.zsu  
Soundprojektabc.zpp

⌚ Select desired file (and thereby also action) per rotary knob.

↓ Press rotary knob

If a decoder software collection file (.zsu) is selected, → it is copied to the **file memory**.  
If a sound project (.zpp) is selected, →the file is copied to the **file memory**.

From this file memory, decoders can be updated later or load sound, see chapter 8.10.

OR (instead of pressing rotary knob)

Press Button **1** (↵) or **Button2 (MENU)** → Immediate start of the **Decoder updates or loading sound**. Further information see chapter 8.10

In case, no selection was made beforehand, and the flash drive contains several .zsu-files (software update) or .zpp-files (sound projects):  
- the file added last to the flash drive is used.  
- if used for several decoders, connected one after the other: the same file.

HOW THE UPDATE OF THE DECODER (OR LOADING SOUND) IS DONE  
SEE CHAPTER 8.10

### 8.10 Decoder Update and Sound loading; directly from the flash drive or the MX10's file memory

THIS FUNCTION IS NOT YET IMPLEMENTED - THIS IS A DESCRIPTION OF THE PROJECT

Starting point normal screen **BLUE**

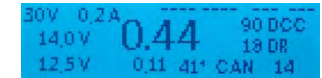

**EITHER (from the flash drive)**

⇒ (Flash drive) **flash drive** with decoder software collection file and/or sound projects (see chapter 8.9)

→ Display colour changes to **TURQUOISE** and lists the found files

Sammelfilexyz.zsu  
▶ Sammelfile1234.zsu  
Soundprojektabc.zpp

**OR (from the file memory)**

Starting point (also) normal screen **BLUE**

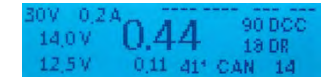

**no flash drive** is inserted, take decoder update or sound project files from then **file memory** (described in chapter 8.9 how those files are entered into this file memory).

Sammelfilexyz.zsu  
▶ Sammelfile1234.zsu  
Soundprojektabc.zpp

#### HOW DECODER UPDATES ARE DONE:

As soon as the decoder (or a vehicle with a decoder) is connected to the update track (track 2), (this can be done before or after a specific files is selected), a line with the decoder data is displayed (type, current SW version)

ZIMO MX645 SW 30.06  
▶ Sammelfile1234.zsu  
Soundprojektabc.zpp

⌚ Scroll with rotary knob (if various files are displayed): Cursor (▶) to desired file

DEC-UPDATE Adr. 1016  
ZIMO MX645 SW 30.06  
Sammelfilexyz.zsu

↓ Press rotary knob → information to selected file (version) and decoder is shown.

↓ Press rotary knob (again) → run software update.

After about 10 sec. the update is finished, Display shows a 100% bar → **GREEN**

DEC-UPDATE 1016  
ZIMO MX645 SW 30.06  
Sammelfilexyz.zsu

**9. "Roco Z21" app and other apps on the MX10**

The Roco app "Roco Z21" for smartphones or tablets can be used in combination with the ZIMO central command station MX10. Therefore, the app is downloaded from Roco's website and installed (see Roco instructions).

The MX10 is connected via the LAN socket to a standard WIFI router (preferably bought in Europe). The smartphone or tablet is connected to the WIFI router as usual (selecting network, entering password, etc.).

Opening the (previously installed) app starts it. In "App settings" the IP address has to be entered. For the ZIMO central command station, the IP address by default is (as long as it is not changed in the MX10 menu):

**192.168.1.145** (in the MX10 Menü / PC Config+Monitor as „LAN IP: 192.168.001.145")

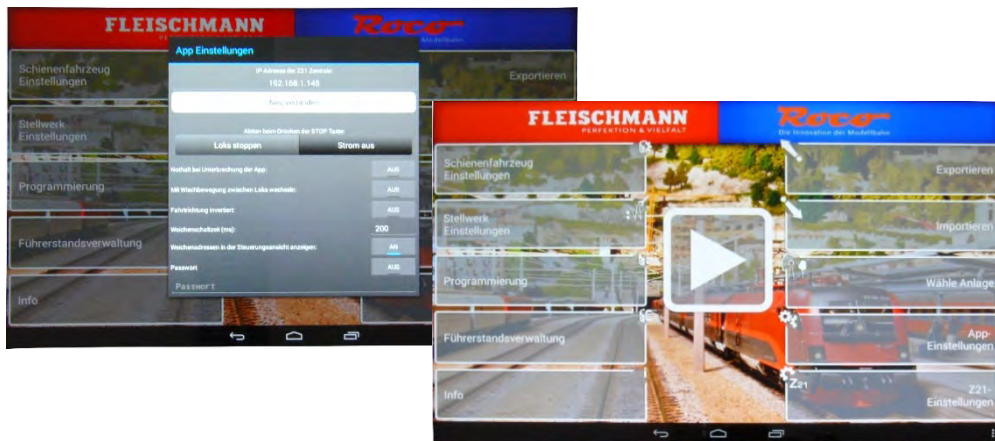

After clicking "New connection", the connection is confirmed and normal operation can be started after defining the vehicles (see Roco instruction manual).

In case, NO connection (WIFI symbol in the status bar in the upper right corner) can be made (IP address of the MX10 does not correspond to the router), the IP address on the MX10 has to be changed. The IP address has to be in the range:

- 192.168.0.0 to 192.168.99.255
- 10.0.0.0 to 10.99.99.255
- 172.16.0.0 to 172.31.99.255, MUST NOT be in a DHCP-area and has to be static. (Configuration on the MX10 see bottom of this page).

If this does not help, the router has to be connected to the computer to determine the router's IP address (see chapter 10 "Interlocking program "ESTWGJ" on the MX10") and the MX10 and the router have to be matched.

If the Roco app and the MX10 connect (green WIFI symbol on the app's screen), vehicles can be defined under "rail vehicle settings". Afterwards, driving operation (big arrow-symbol in the middle of the screen) can be started. **Regarding usage of the "Roco Z21" app, consult Roco instruction manuals!**



**In case, changes in the MX10's IP address have to be made** (see above):

Open the MX10 menu and the settings for "PC Config+Monitor" and:

- ↶ Set the cursor (▶) with the rotary knob on "LAN IP" and afterwards
- ⏴ Press rotary knob → the area that can be configured is framed and can now be adjusted by the rotary knob; to change the following numeric block, press
- Button1** (1) → the next numeric block is framed and is also adjusted with the rotary knob. By pressing button 1, the system always jumps to the next triplet (to the right).
- ⏴ Pressing the rotary knob again → configuration mode is terminated and adjusted values stored, the rotary knob can now be used to scroll (cursor position).

```
ABA In/Out Manitar+Conf
Bus Config+Manitar
▶ PC Config+Manitar
```

```
Manitar
VCam: LAN Made
▶ LAN IP: 192.168.001.145.
```

```
Manitar
VCam: LAN Made
LAN IP: 192.168.000[102]
```

Afterwards, the app is started again and connected to the MX10 with the new IP address.

**ATTENTION:** in the corresponding app, the receiving port has to show the MX10's address and vice-versa. When using PCs, the application and the used ports have to be unlocked in the firewall.



**10. Interlocking Program "ESTWGJ" on the MX10**

**ESTWGJ** (by Heinz-Willi Grandjean, [www.ESTWGJ.com](http://www.ESTWGJ.com)) provides a prototypical display of interlocking (since 2018 also electronic interlocking) in a model interlocking. Main tasks are the prototypical processes for controlling and solving for train and shunting lines.

ESTWGJ is compatible with Windows XP, 7, Vista, 8, 10 (and future versions); preferably use the newest version, because its functionality is considered when developing.

The connection between computer and MX10 can be established via USB or LAN (also WIFI). The simplest is the connection via LAN and also the most effective in usage (USB connection see description in the following chapter).

The ethernet or LAN cable leads from the LAN socket on the back of the MX10 either

- directly to the computer (it must have an individual IP address, see below), or
- if at the same time an external WIFI router is used, e.g. for the Roco App, it leads to the WIFI router. The router can be connected via another ethernet cable or WIFI. The router assigns IP addresses to the connected devices. The MX10 has to have an IP address that corresponds to the range of static IP addresses of the router (see instruction manual of the router).

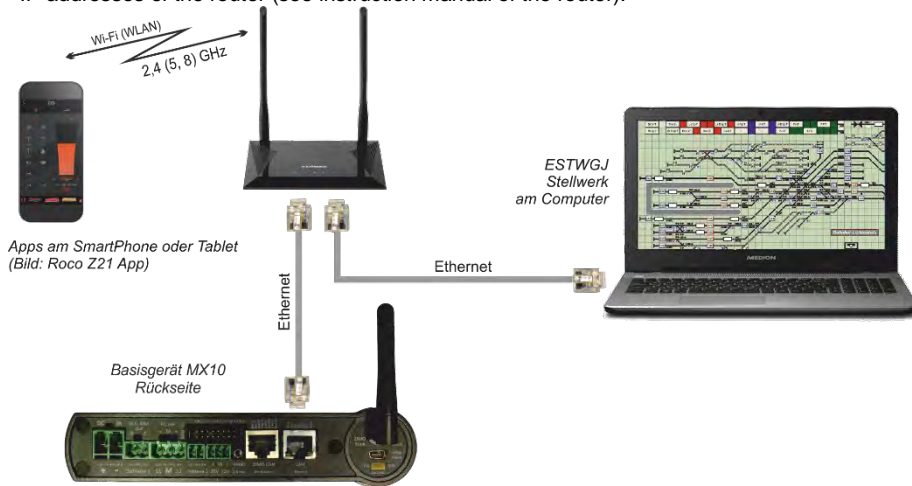

**Necessary actions on the computer when connecting it directly via LAN cable:**

Only use crosslink LAN cables.

The PC / Laptop has to have a **static IP address** corresponding to the principles described below.

In case of a firewall, it has to be ensured that the MX10 sends data via the UDP ports 14520 (PC sends) and 14521 (PC receives commands; these ports are configured by default in the MX10 and can be changed in the MX10 menu under "PC Config+Monitor" / "Z20 Rx") to the PC.

There are different possibilities to get to the window for the "Internet protocol settings, Version 4 (TCP/IPv4)", in which the actual settings can be done, among them the following (Windows 10):

- Calling-up (e.g. Windows button, -> "Windows settings" -> "Networks and Internet") to
- Window "Network and Sharing Center": clicking on "Ethernet" leads to
- Window "Status and Ethernet": clicking on "Settings" leads to
- Window "Properties of Ethernet": clicking on "Internet protocol, Version 4 (TCP/IPv4)" and "Properties" leads to
- Window "Properties of Internet protocol, Version 4 (TCP/IPv4)": here, the actual entries are made:

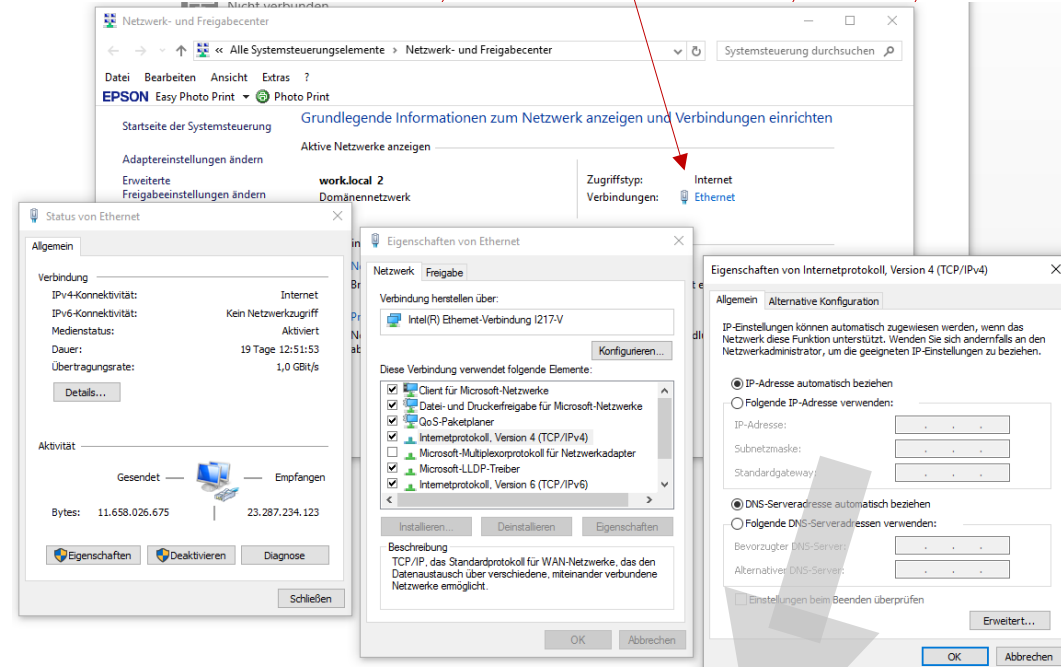

Clicking on "Use the following IP address" and enter

for example **192.168.1.100 \***

\* if "100" is already used by a device via "LAN", another value can be used

The box "Subnetmask" is filled automatically (if not: enter 255.255.255.0).  
OK, OK, OK, ...

IP-Einstellungen können automatisch zugewiesen werden, wenn das Netzwerk diese Funktion unterstützt. Wenden Sie sich andernfalls an den Netzwerkadministrator, um die geeigneten IP-Einstellungen zu beziehen.

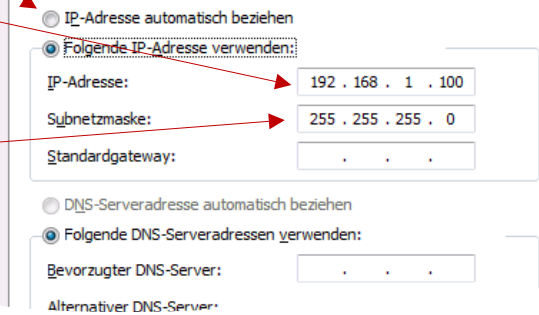

**Necessary actions in ESTWGJ:**

Enter the MX10's IP address in the box with the red frame: **192.168.1.145** \*)

\*) This is an IP address entered by the manufacturer. In case, a change was made, it has to be made here, too.

If a ✓ is entered in "Create-Log-file" in the blue frame, **ESTWGJ** creates a log file, which writes all LAN commands on the screen. This is not relevant for normal operation, but can be interesting sometimes (e.g. searching for bugs).

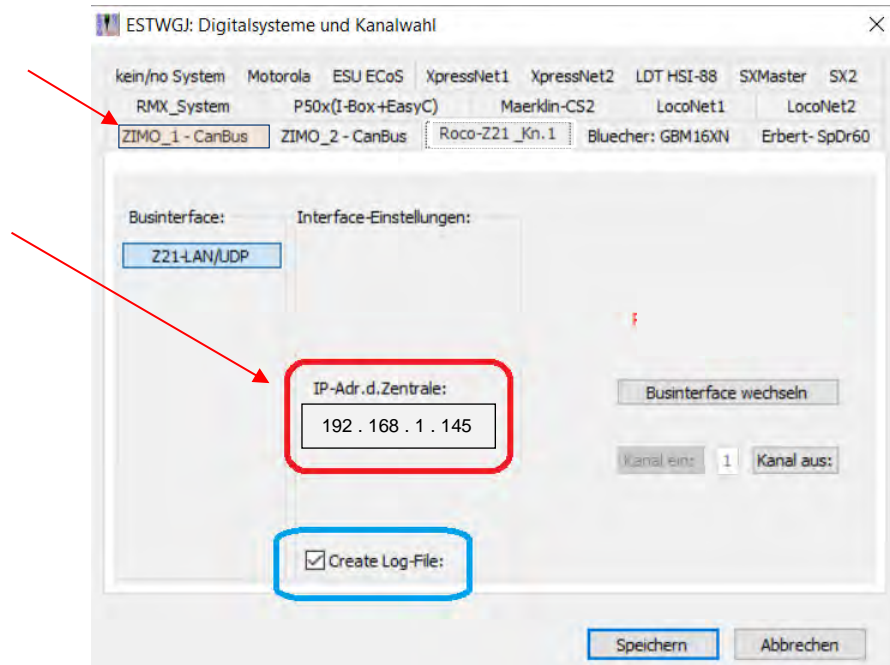

After "Saving" these settings in **ESTWGJ** the connection works.

As described here for ESTWGJ, other interlocking programs can be connected to the MX10.

**NOTE:** MX10 can not communicate via LAN **and** USB at the same time.  
As soon as the MX10 recognises a valid LAN connection, USB is deactivated.

PC (with interlocking software) and MX10 can also be connected via WIFI.

Therefore it is important that the PC gets an IP address automatically assigned from the router. All those assigned IP addresses have to be static. Consult the instruction manual of your router.

## 11. USB connection to the computer

This is a general description, valid for different applications, but NOT a certain program.

For the PC to communicate with an MX10 via USB, they have to be interconnected by a cable type “A to mini B”. The “USB client” socket on the MX10 is in the back, beneath the antenna. The necessary **driver** is usually automatically installed and a new COM port can be read out in “Connections (COM & LPT)” in the device manager. This COM port has to be changed to Com port 10.

In case, the COM interface was not automatically installed, do it manually by following the described procedure: Connect MX10 to USB and turn it on. On the computer the “Control panel” opens; an in it the “device manager”:

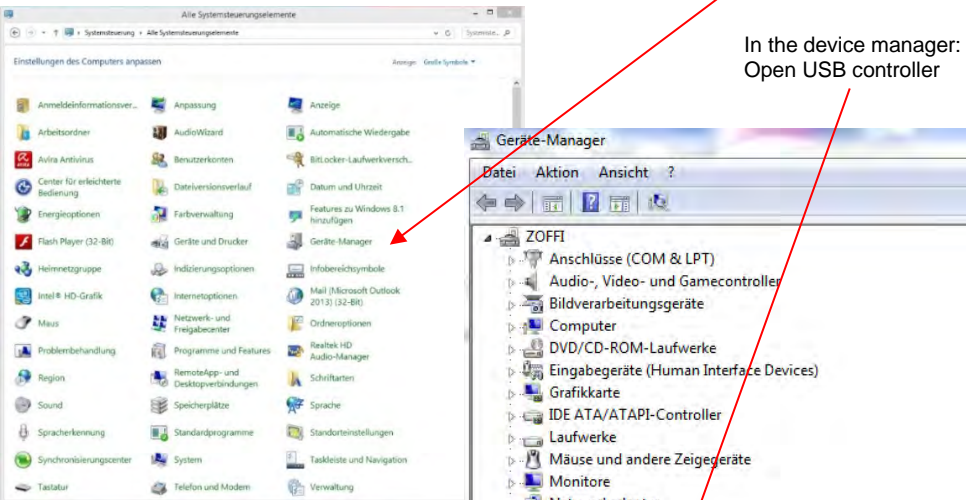

In the device manager:  
Open USB controller

- ▼ USB-Controller
  - ASMedia USB 3.1 eXtensible-Hostcontroller – 1.10 (Microsoft)
  - Corsair Hydro Series 7289 USB Device
  - Generic USB Hub
  - Generic USB Hub
  - Generischer Hochgeschwindigkeits-USB-Hub (SuperSpeed)
  - Generischer Hochgeschwindigkeits-USB-Hub (SuperSpeed)
  - Generischer USB-Hub
  - Generischer USB-Hub
  - Generischer USB-Hub
  - Generischer USB-Hub
  - Generischer USB-Hub
  - Generischer USB-Hub
  - Generischer USB-Hub
  - Generischer USB-Hub
  - Intel(R) USB 3.0 eXtensible-Hostcontroller – 1.0 (Microsoft)
  - Logitech USB Camera (HD Webcam C270)
  - Microsoft Mouse and Keyboard Detection Driver (USB)
  - Standard PCI-zu-USB erweiterter Hostcontroller
  - Standard PCI-zu-USB erweiterter Hostcontroller
  - USB Serial Converter**
  - USB-Massenspeichergerät
  - USB-Root-Hub

Open “USB serial converter”

Open the tab “Extension” and activate “load VPC”.

if this tab is not available, select the second tab “Driver”, select “Update driver”.

Now the device manager shows “unknown object” - update the driver also in this place. If all those steps were carried out successfully, the device manager shows under “Connections” (COM & LPT):

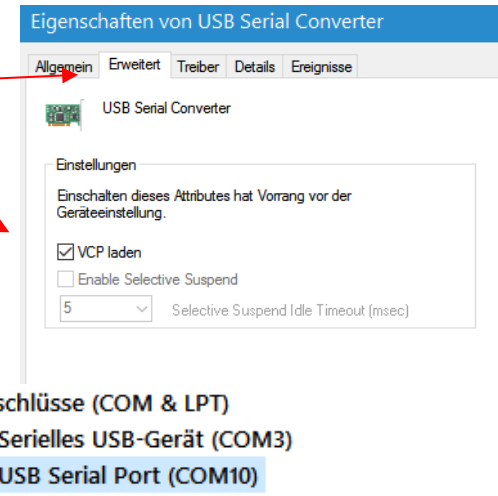

If COM port 10 is not yet used, select it.



**Annex: EMV audit report / TÜV Austria**

Concerning the MX10 command station and MX32 controller.

<b>TEST REPORT</b> of the accredited test laboratory  <b>TÜV Nr.: INE-ATIEMV-17/105</b>  about the following EMC - test/ - research		 <b>TÜV AUSTRIA</b> <b>SERVICES GMBH</b>  Office: Deutschstrasse 10 1230 Vienna/Austria T: +43 5 0454 0 F: +43 5 0454 6935 E: <a href="mailto:info@tuv.at">info@tuv.at</a> W: <a href="http://www.tuv.at">www.tuv.at</a>  Business Area Industry & Energy Austria Technik  TÜV™
<b>Applicant:</b>	ZIMO Elektronik GmbH Schönbrunner Straße 188 A-1120 Vienna	  Testing Laboratory, Inspection Body, Certification Body, Calibration Laboratory, Verifizierungsgesellschaft  Notified Body 6408  Non-executive Board of Directors: RIT Dr. Johann Neuhart  Management: Dr. G. Stefan Hahn Mag. Christoph Werninger  Registered Office: Deutschstrasse 10 1230 Vienna/Austria  Branch Offices: <a href="http://www.tuv.at/standorte">www.tuv.at/standorte</a>  Company Register Court / - Number: Vienna / FN 285475 F  Bank Details: IBAN AT13120002049001906 BIC BRAUAT33  IBAN A15310000104893282 BIC ROBAAT33  VAT ATU63240-089 DNR 3002476
<b>Product:</b>	Digital Command Station --> MX10 Radio cab --> MX32FU	
<b>Serial Number:</b>	—	
<b>Standard:</b>	EN 55014-1:2006+A1:2009+A2:2011; EN 55014-2:2015; EN 61000-6-1:2007; EN 61000-6-3:2007+A1:2011+AC:2012;	
<b>TÜV AUSTRIA SERVICES GMBH</b> Test laboratory for EMC  Deputy Supervisor of EMC- laboratory  Ing. Andreas Malak   17.01.2017 Checked by  Ing. Michael Emminger  Copy Nbr.: <u>11</u>  A publication of this test report is only permitted literally. Copying or reproduction of partial sections needs a written permission of TÜV AUSTRIA SERVICES GMBH The results of this test report only refer to the provided equipment.		
QFN-EMV_Prozokoll_e Rev 01/EMV17-105.docx		Page 1 of 30

**Annex: Declaration of Conformity and Warranty****Declaration of Conformity:**

ZIMO Elektronik GmbH hereby declares that the product MX10 bears the EC mark and is built in accordance with the provisions of Directives 88/378 / EEC; 89/336 / EEC; 73/23 / EEC.

**24 months warranty:**

Our products are technically sophisticated and are manufactured and tested with utmost care, therefore, ZIMO Elektronik GmbH guarantees their products for 24 months from the date of purchase (with proof of purchase from a ZIMO contractor).

The warranty covers the repair or replacement of defective parts. ZIMO Elektronik GmbH reserves the right to proceed at its own discretion only if the damage is proven to be the result of a design, manufacturing, material or transport fault. A repair does not extend the warranty. Warranty claims can be made with a ZIMO contract partner or ZIMO Elektronik GmbH. Proof of purchase is required.

The warranty does not apply:

- with normal wear and tear
- if devices are not used for the purpose intended by ZIMO Elektronik GmbH and in accordance with its operating instructions
- in case of modifications or alterations not performed by ZIMO Elektronik GmbH.

ZIMO Elektronik GmbH  
 Schönbrunner Strasse 188  
 1120 Vienna  
 Austria